

dB

THE SOUND ENGINEERING MAGAZINE
APRIL 1976 \$1.00



IN THIS ISSUE

- Enhancement: An Artistic Tool
- Zen and the Art of Recording
- Sound Reinforcing "The Midnight Special"

AKJDM325COM11 04 DB JAN79
 KJCM RADIO
 D 5 50 UNIV OF WASH
 325 COMMUNICATIONS BLDG
 SEATTLE WA 98105

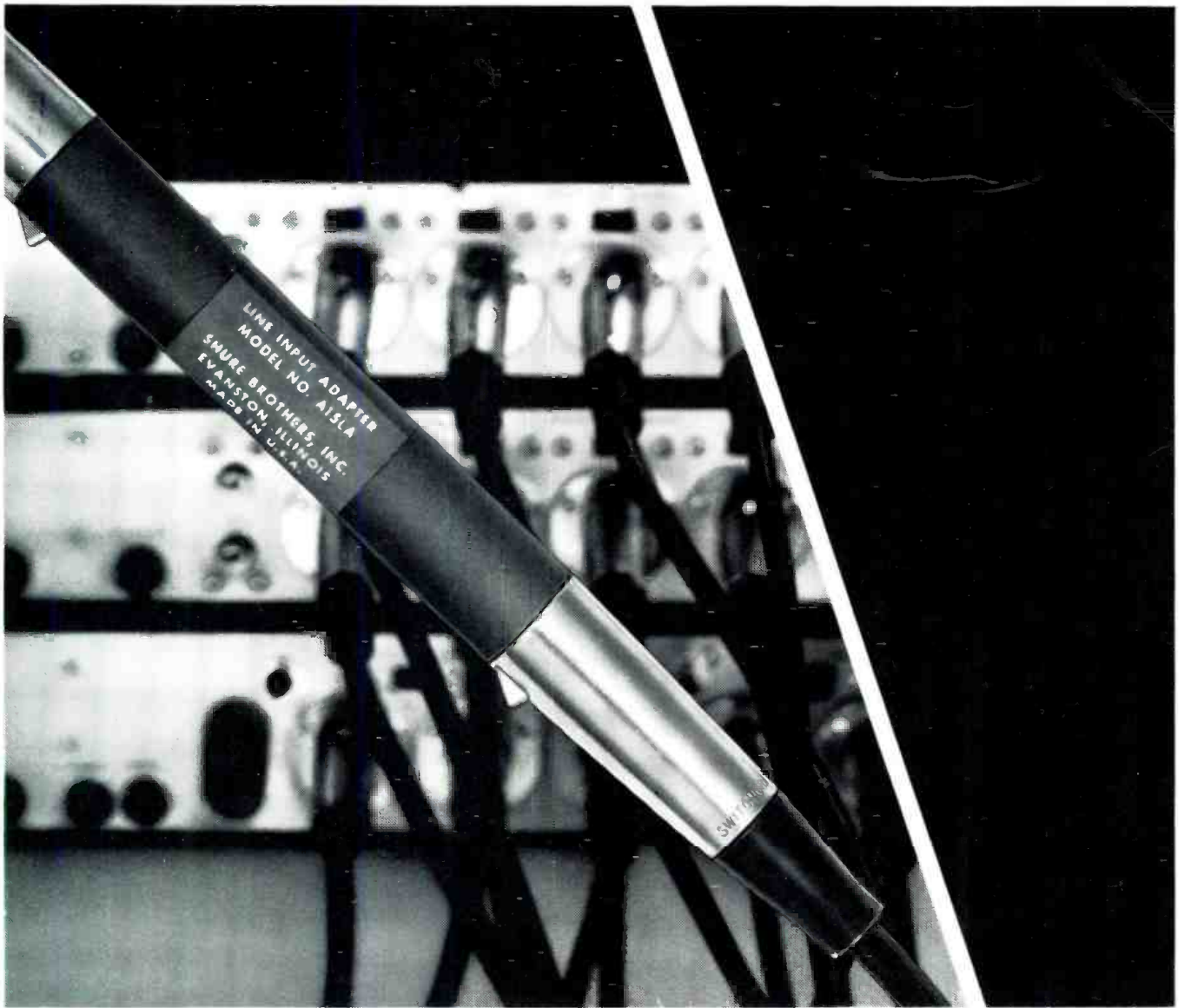

Solve 9 problems in seconds!

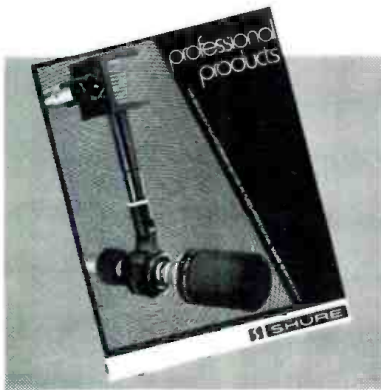

Eliminate hours of on-the-job rewiring with the Shure A15 series of plug-in line adapters, each of which can be put to use in seconds. For a small outlay, you can have any of the nine Shure miracle workers: Model A15A prevents input overload; A15LA converts a mic input to a line input; A15HP minimizes low frequency rumble; A15LP cuts off high frequency noise; A15PA adds extra brilliance and "presence"; A15RS filters sibilant sounds; A15PR reverses the phase of a line; A15BT matches impedances; and A15TG generates a trouble-shooting tone in scrambled wires. Read about these A15's in our catalog and we promise to save you hours of work.

Shure Brothers Inc.
222 Hartrey Ave., Evanston, IL 60204
In Canada: A. C. Simmonds & Sons Limited



Manufacturers of high fidelity components, microphones, sound systems and related circuitry.

Circle 10 on Reader Service Card

www.americanradiohistory.com

**coming
next
month**

● **db** takes another look at the digital delay line in Richard Factor's **THE DIGITAL DELAY LINE REVISITED** featuring flexible Random Access Memory.

● A simplified method of connecting a variable speed oscillator is described in **A VSO SWITCHING SYSTEM**, by Robert Runstein.

● Everything you've wondered about and didn't know whom to ask regarding proliferation of digital clocks on the market is explained by Robert Berglas in **DIGITAL CLOCKS AND THINGS**.

● Among our columnists, Patrick Finnegan will discuss remote pickups, Norman Crowhurst delves further into waveforms and loudspeakers, and Martin Dickstein promises hints on videotape editing.



THE SOUND ENGINEERING MAGAZINE

APRIL 1976, VOLUME 10, NUMBER 4

24	ENHANCEMENT, AN ARTISTIC TOOL Don Davis and Ron Wickersham
32	ZEN AND THE ART OF RECORDING R. A. Neilson and Bobby Goldstein
38	SOUND REINFORCING 'THE MIDNIGHT SPECIAL' Lothar A. Krause, Jr.
41	THE CONTRIBUTIONS OF EDESEL MURPHY TO THE UNDERSTANDING OF THE BEHAVIOR OF INANIMATE OBJECTS D. L. Klipstein
2	INDEX TO ADVERTISERS
4	LETTERS
6	CALENDAR
8	FREE LITERATURE
10	THEORY AND PRACTICE Norman H. Crowhurst
14	BROADCAST SOUND Patrick S. Finnegan
19	THE SYNC TRACK John Woram
22	NEW PRODUCTS AND SERVICES
44	CLASSIFIED
48	PEOPLE, PLACES, HAPPENINGS

db is listed in **Current Contents: Engineering and Technology**

Robert Bach **Larry Zide**
PUBLISHER EDITOR

Bob Laurie **John Woram**
ART DIRECTOR ASSOCIATE EDITOR

Eloise Beach **Hazel Krantz**
CIRCULATION MANAGER COPY EDITOR

Lydia Anderson **Ann Russell**
ASST. CIRCULATION MANAGER PRODUCTION

GRAPHICS **Crescent Art Service**

db, the Sound Engineering Magazine is published monthly by Sagamore Publishing Company, Inc. Entire contents copyright © 1976 by Sagamore Publishing Co., Inc., 1120 Old Country Road, Plainview, L.I., N.Y. 11803. Telephone (516) 433 6530. db is published for those individuals and firms in professional audio-recording, broadcast, audio-visual, sound reinforcement, consultants, video recording, film sound, etc. Application should be made on the subscription form in the rear of each issue. Subscriptions are \$7.00 per year (\$14.00 per year outside U. S. Possessions, Canada, and Mexico) in U. S. funds. Single copies are \$1.00 each. Controlled Circulation postage paid at Harrisburg, Pa. 17105. Editorial, Publishing, and Sales Offices: 1120 Old Country Road, Plainview, New York 11803. Postmaster: Form 3579 should be sent to above address.

**about
the
cover**

● Another in a series of interpretive photographs portraying contemporary popular music. (*H. Armstrong Roberts*)



Our second-generation delay system is first in sound reinforcement

Heinz Hall for the Performing Arts, Pittsburgh, a Delta-T installation.

Which should come as no surprise. After all, Lexicon pioneered the first all-electronic audio delay system. Now our second-generation Delta-T 102 is the digital delay system most specified by acoustic consultants and leading sound contractors. They find the Delta-T 102 System significantly improves the intelligibility and naturalness of sound reinforcement installations by acoustically synchronizing sound from multiple speaker locations. The modularity of the Delta-T 102 allows the ultimate in system flexibility. Proprietary digital techniques give such important advantages as 90 dB dynamic range and 0.2% total distortion. A five-position LED headroom indicator with 40 dB range assures straightforward and simple level setting. These systems are easy to install and extremely reliable. Most important, they are the best performing digital delay units available today at any price.

To get the full story, circle reader service number or write Lexicon, Inc., 60 Turner Street, Waltham, Massachusetts 02154. Or call 617-891-6790.

Write on your letterhead for free 14-page application note. AN-2, on sound reinforcement.

Lexicon

60 Turner Street
Waltham, Massachusetts 02154
(617) 891-6790

Circle 12 on Reader Service Card

www.americanradiohistory.com

index of advertisers

Audio-Technica	4
Audironics	Cover 3
Automated Processes	43
Bode Sound	23
Bose Corporation	40
Broadcast Electronics	12
Capitol Magnetic	15
CBS Labs	23
Cetec Audio	36
Clear-Com	19
Communications Co.	18
Community Light & Sound	37
dbx, Inc.	6
Electro-Voice	5
ESE Digitals	40
Eventide Clock Works, Inc.	31
Garner Industries	22, 23
Infonics	11
Kustom Electronics	9
Lexicon	2
R. A. Neilson Co.	18
Orban/Parasound	39
Otari	30
Ramko Research	14, 16
Recording Supply Corp.	20
Revox	13
Robins Industries	20
Shure Brothers	Cover 2
Sound Technology	21
Soundcraftsmen	10
Sound Workshop	47
Speck	8
Standard Tape Labs	8
Stanton Magnetics	17
Willi Studer America	29
TEAC Corp. of America	Cover 4
Telex	7
White Instruments	3
Woram Audio	20

db sales offices

THE SOUND ENGINEERING MAGAZINE

New York

1120 Old Country Rd.
Plainview, N.Y. 11803 516-433-6530

Roy McDonald Associates, Inc.

Dallas

Stemmons Tower West, Suite 714
Dallas, Texas 75207 214-637-2444

Denver

3540 South Poplar St.
Denver, Colo. 80237 303-758-3325

Houston

3130 Southwest Freeway
Houston, Tex. 77006 713-529-6711

Los Angeles

500 S. Virgil, Suite 360
Los Angeles, Cal. 90020 213-381-6106

Portland

2035 S. W. 58th Ave.
Portland, Ore. 97221 503-292-8521

San Francisco

Suite 265, 5801 Christle Ave.
Emeryville, Cal. 94608 415-653-2122

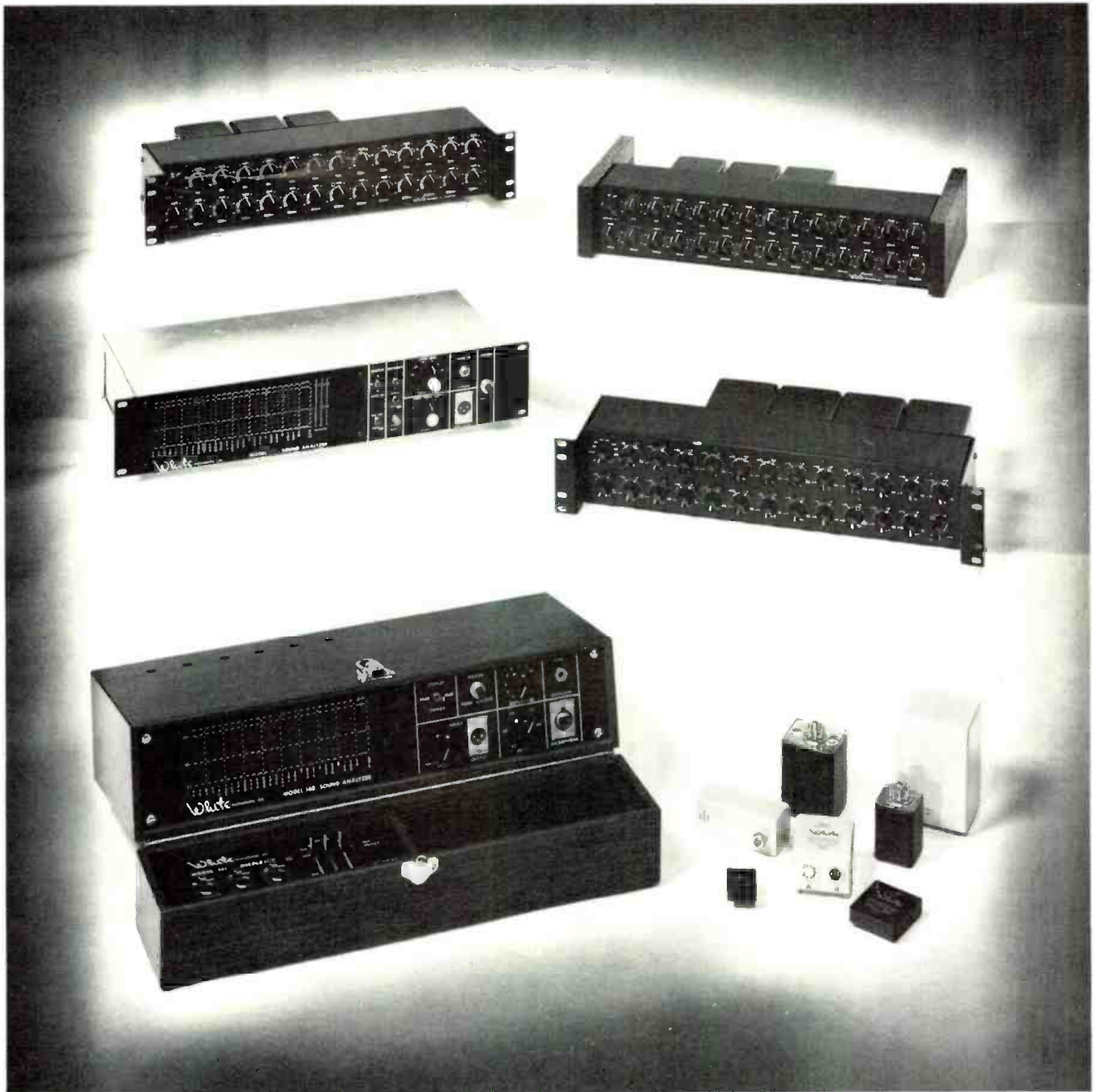

Clockwise from
bottom left.

ANALYZERS — EQUALIZERS — FILTERS

MODEL 140 SOUND ANALYZER: For acoustic analysis. 27 one-third octave double-tuned filters, 40 Hz through 16 kHz, plus broadband dB SPL. Built-in noise generator. LED display. \$3620.

MODEL 141 MICPLEXER (shown in lid): Multiplexes three microphones and presents the signal to the Model 140 for analysis of sound field. \$402.

MODEL 142 SOUND ANALYZER: Peak reading for the analysis of program material. 27 one-third octave single-tuned filters, 40 Hz through 16 kHz plus broadband dBm. Line level input. Two CMOS memories and built-in noise generator. LED display. \$3200.

SERIES 4000 ACTIVE EQUALIZERS: Model 4001 has 27 one-third octave cut/boost channels from 40 Hz through 16 kHz plus low end

roll-off adjustment. ± 10 dB range. Noise -90 dBm. Transformer coupled input. Provision for insertion of bi-amp network. \$690.

Model 4002 designed for home use. Similar to 4001 but has phono jack type connectors and wooden end pieces. \$690.

MODEL 4004 PASSIVE EQUALIZER: 24 one-third octave cut only channels from 63 Hz through 12.5 kHz. Double-tuned constant-K filter sections give -15 dB of range. High end and low end roll-off adjustments. Provision for insertion of bi-amp network. \$760.

FILTERS: White Instruments can supply high-pass, low-pass, band-pass, and band-reject filters to your specifications at reasonable prices.

For further information,
call or write

White

WHITE INSTRUMENTS, INC. P. O. Box 698
Austin, Texas 78767 512/892-0752

Dealer inquiries invited.

Circle 13 on Reader Service Card

www.americanradiohistory.com

The phono cartridge that doesn't compromise any modern record.

AT15Sa



Choosing an AT15Sa can add more listening pleasure per dollar than almost anything else in your hi-fi system. First, because it is one of our UNIVERSAL phono cartridges. Ideally suited for every record of today: mono, stereo, matrix or discrete 4-channel. And look at what you get.

Uniform response from 5 to 45,000 Hz. Proof of audible performance is on an individually-run curve, packed with every cartridge.

Stereo separation is outstanding. Not only at 1 kHz (where everyone is pretty good) but also at 10 kHz and above (where others fail). It's a result of our exclusive Dual Magnet* design that uses an individual low-mass magnet for each side of the record groove. Logical, simple and very effective.

Now, add up the benefits of a genuine Shibata stylus. It's truly the stylus of the future, and a major improvement over any elliptical stylus. The AT15Sa can track the highest recorded frequencies with ease, works in

*TM. U.S. Patent Nos. 3,720,796 and 3,761,647.

any good tone arm or player at reasonable settings (1-2 grams), yet sharply reduces record wear. Even compared to ellipticals tracking at a fraction of a gram. Your records will last longer, sound better.



Stress analysis photos show concentrated high pressure with elliptical stylus (left), reduced pressure, less groove distortion with Shibata stylus (right).

The AT15Sa even helps improve the sound of old, worn records. Because the Shibata stylus uses parts of the groove wall probably untouched by other elliptical or spherical styli. And the AT15Sa Shibata stylus is mounted on a thin-wall tapered tube, using a nude square-shank mounting. The result is less mass and greater precision than with common round-shank styli. It all adds up to lower distortion and smoother response. Differences you can hear on every record you play.

Don't choose a cartridge by name or price alone. Listen. With all kinds of records. Then choose. The AT15Sa UNIVERSAL Audio-Technica cartridge. Anything less is a compromise.

audio-technica

INNOVATION □ PRECISION □ INTEGRITY



AUDIO-TECHNICA U.S., INC., Dept. 46DB, 33 Shiawassee Ave., Fairlawn, Ohio 44313

db letters

THE EDITOR:

What a comfort to read Norman Crowhurst's column. *Theory & Practice* in the February issue of *db*. I am sitting in bed with a severe cold trying to organize my notes for tomorrow's class. I teach a course in Audio Techniques for the theatre. For the past five years I have been struggling with the problem of the proper balance between theory and practical experience. I've also been trying to boil down some of the hard theory into practical, usable lay terminology. Of course, since my subject is limited to doing sound for the theater I do not have quite such a bulk of theory to deal with. But with only one semester of two hours a week it is still difficult to get all the information in and leave time for student creativity. I have finally settled on explaining whys and hows and telling the students to look up specifics in various publications if they need more information. It seems to be working—the less cut and dried the classroom work is, the more creative the students are.

I have finally developed my course into a textbook which is to be published this spring by the Richards Rosen Press, New York. Unfortunately, the book is part of a series, called *THE THEATRE STUDENT*, which is used in high schools as well as colleges, so I had the added problem of making the book basic enough for beginners without being boringly dull for people with more background.

Thank you for Mr. Crowhurst's continuing excellent columns.

CAROL M. WAASER
Yale Drama School
New Haven, Conn.

THE EDITOR:

I'm trying to develop a practical knowledge of professional audio electronics on my own and I've run into a dead end. I hope you can help me.

The subject I'm pursuing is the use of passive gyrators as an inductor replacement. I have the following questions on them.

First, is there any literature on the practical use of gyrators that can be used as a quick circuit building guide?

In what forms are gyrators being integrated and where are they available i.e., discrete gyrators, inductor replacements with specific values of L & Q, filters with rolloff ratios or bandpass.

How widespread is their use in "state of the art" circuitry?

Information from some knowledgeable readers will be appreciated.

DALE SOUTHARD
1175 Elgin Ave.
Salt Lake City, Utah 84106

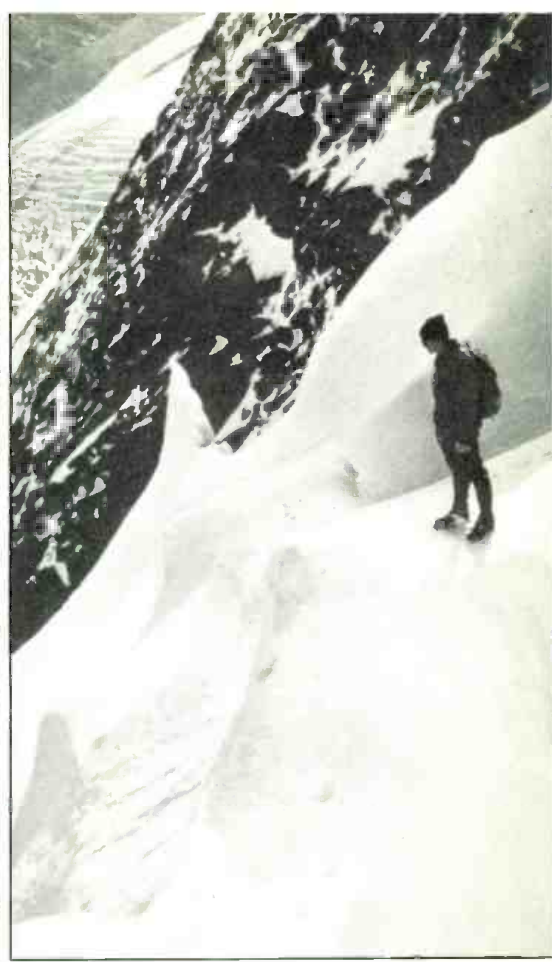
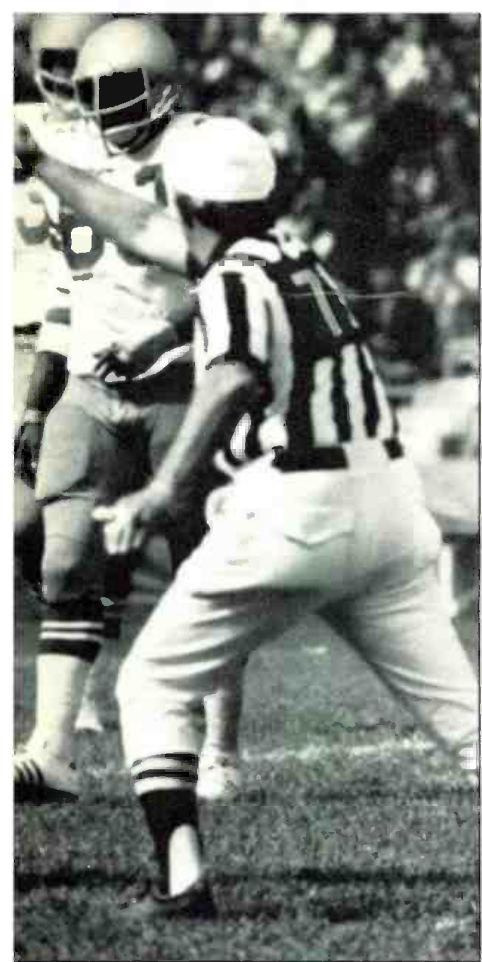

And now to our Electro-Voice wireless remote, folks...

Broadcast, cinema, stage... wherever you can't work with a cable, the new Electro-Voice Wireless Microphone System helps you work better and easier than before.

Reliability.

Lemo Quick-Loc connectors on mike and antenna leads for positive connections, superior flex and strain relief. Transmitter package is small, rugged, carefully insulated inside a

tough diagonally sectioned aluminum case. It's easy to conceal, takes abuse—even being sat on or dropped—and keeps working.

Increased Range.

A significant increase in radiated output over other wireless systems results in clean, non-fading reception over more than normal distances. Reduces r.f. interference. In addition, radiated output power can be doubled to 100mw via a simple switching arrangement in the transmitter... a great help in severe conditions.

Best Performance.

Built-in audio compressor. LED indicator on transmitter is adjustable to optimize signal-to-noise ratio and

dynamic range. Double-tuned helical resonator RF preselector in the receiver prevents out-of-band interference and "AUTOLOCK" discriminator eliminates drift.

Versatile.

Any E-V dynamic or electret condenser microphone (and many others) can be used with the transmitter. Bias voltage for electrets is available and eliminates a separate microphone battery. Automatically selectable to internal or external power supplies. Accessory connector on receiver provides additional balanced audio output; diversity sense output; regulated 7.5-V/100-mA output; external power input; and ground. Receiver operates from external AC power, external DC (10-30 V), or batteries.

With Electro-Voice, the show goes on. And on. For full details write:



Circle 14 on Reader Service Card

www.americanradiohistory.com

Electro-Voice^{INC.}
a **gulton** company

Dept. 4 61BD, 686 Cecil Street
Buchanan, Michigan 49107

this noise reduction system reduces tape hiss by about 14 dB

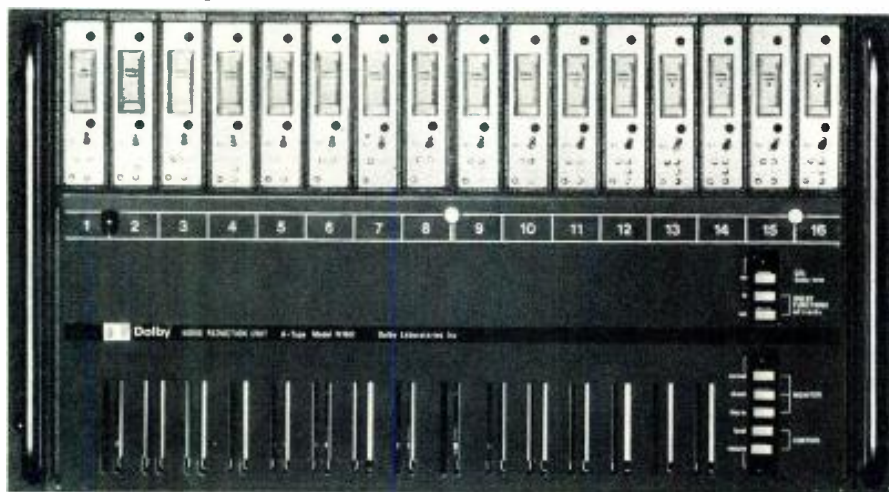

this dbx 216 system reduces tape hiss to inaudibility



try
dbx noise elimination

dbx

dbx, Incorporated
296 Newton Street
Waltham, MA 02154

Circle 15 on Reader Service Card

CALENDAR

APRIL

- 22 **Acoustical Conference.** Hungarian Society for Optics, Acoustics, and Cinematography. Budapest, Hungary.
- 26-27 **Acoustical Problems of Light-Structure Construction of Buildings.** Acoustical Commission of the Hungarian Academy of Sciences. Budapest, Hungary.

MAY

- 1 **Midwest Acoustics Conference.** One-day meeting covering signal processing and data reduction technology for solving technical and legal problems in acoustics. Norris Center, Northwestern University, Evanston, Ill. Contact: H. O. Saunders, Rm. 24A, 225 W. Randolph St., Chicago, Ill. 60606. (312) 727-4331.
- 4-7 **Audio Engineering Society Convention,** Hilton Hotel, Los Angeles, Ca. Contact: A.E.S. 60 E. 42nd St., New York, N.Y. 10017.
- 4-5 **B & K Seminar: Microphones & Accelerometers.** Contact: B & K Instruments, 5111 W. 164th St., Cleveland, Ohio 44142. (216) 267-4800.
- 25-27 **B & K Seminar: Human Acoustics.**
- 25-27 **Synergetic Audio Concepts Training Session,** Chicago, Ill. Contact: Don Davis, P.O. Box 1134, Tustin, Ca. 92680. (714) 838-2288.
- 28-31 **Sound and Vision '76.** Birmingham, England.

JUNE

- 7-11 **B & K Seminar: Industrial Noise Control.** Contact: B&K Instruments, 5111 W. 164th St., Cleveland, Ohio 44142. (216) 267-4800.
- 8-10 **Synergetic Audio Concepts Training Session.** Columbus, Ohio. Contact: Don Davis, P.O. Box 1134, Tustin, Ca. 92680. (714) 838-2288.
- 8-11 **Communications '76,** Brighton, England. Contact: British Information Services, 845 Third Ave., New York, N.Y. 10022. (212) 752-8400.
- 8-11 **Information Retrieval Exhibition,** London, England. Contact: British Information Services.
- 8-11 **International Audio-Visual Aids,** London, England. Contact: British Information Services.

We Offer Our Complements

Modular tape components that complement each other so you can design any customized tape system you need. Heavy duty, reel-to-reel or tape cartridge transports in one, two or four channel configuration complemented by separate record/play or play only electronics. Your choice of tape speeds, options and accessories including remote control.

- You rarely see our tape components because they work behind the scene. They work day

in, day out at broadcasting commercials or monitoring spacecraft, activating machinery and displays, playing background music, repeating announcements or recording scientific research data. They monitor the speed of a train, record patrol car communications or provide the roar of an amusement park dinosaur. They record medical data, log security information and emit high pitched sound for warehouse rodent control. And they serve as court recorders, in

typing pools and dial access systems. They work continuously.

- When you design a custom tape system to record, to monitor or to play, specify reliable Telex tape components. You'll collect the compliments. With our complements. For detailed information please write:



PRODUCTS OF SOUND RESEARCH

TELEX

COMMUNICATIONS, INC.

9600 ALDRICH AVE. SO. • MINNEAPOLIS, MINN. 55420 U.S.A.
Europe: 22, rue de la Legion-d'Honneur, 93200 St. Denis, France
Canada: Telak Electronics, Ltd., Scarborough, Ontario

Circle 16 on Reader Service Card

You're
in
Good

company

when you use STL magnetic Test Tapes

STL magnetic test tapes are widely used by major recording studios, equipment manufacturers, government and educational agencies throughout the world. The most comprehensive test tapes made they are offered in 1" and 2" sizes as well as flutter tapes and all other formats.

You know your system is in step with the rest of the industry, compatible and interchangeable, when you employ STL tapes, the most accurate reference available.

Write for a free brochure and the dealer in your area.

Distributed exclusively by Taber Manufacturing & Engineering Co.

STL

STANDARD TAPE LABORATORY, Inc.

2081 Edison Avenue
San Leandro, CA 94577
(415) 635-3805

Circle 32 on Reader Service Card

Every disco needs a "DJ" for trouble-free mixing.



And Speck's portable "DJ" Board is just the one. Simple, compact (16x11) rugged construction with American-made components. It has all the features you need for professional broadcast standard record/playback system: stereo inputs for 2 turntables, tape or cartridge players and jack for stereo headphone cuing; mike input; hi and low frequency equalization; superb slide lever controls for all main functions including master fader; talkover switch with adjustable muting. Compatible with any type power amp. Signal to noise ratio 75dB; distortion 01%.

And lists for Only \$490

Call, write or wire for
spec sheets, or equipment, from

SPECK
ELECTRONICS

11408 Collins St., N. Hollywood, Ca. 91601 • Phone (213) 980-9919

Circle 17 on Reader Service Card

FREE LITERATURE

STUDIO FURNITURE

Racks, cabinets, and console tables, as well as audio control consoles, tone arms, and a preamplifier are described in this brochure. Mfr: Micro-Trak
Circle 85 on R.S. Card.

RF SEMICONDUCTORS

A new 16-page catalog describes HF, UHF, VHF, single sideband and microwave discrete transistors and amplifier modules plus other transistor and amplifier products. Mfr: TRW.
Circle 86 on R.S. Card.

APCO SIGNALS

A pocket-sized chart gives emergency information used by the Associated Public Safety Communications Officers, including the revised emergency signals and official listing of alphabetical code names. Mfr: Siltronix.
Circle 88 on R.S. Card.

TAPE SPLICER

This catalog sheet describes the operation and specifications of the SFE-1 splice finder and eraser. Mfr: UMC Electronics.
Circle 89 on R.S. Card.

TRANSFORMERS

A 48-page catalog details approximately 1,000 products, principally transformers and items relating to transformers. Mfr: Thordarson Meissner.
Circle 90 on R.S. Card.

PUSHBUTTON SWITCHES

Complete specifications for an extensive line of illuminated pushbutton switches is contained in this catalog. Mfr: Dialight.
Circle 91 on R.S. Card.

HOCKEY PUK DIODE

This data sheet describes the new 2000 amp Hockey Puk diode with voltage ratings to 2000 V and a 30,000 A surge rating. Mfr: International Rectifier.
Circle 92 on R.S. Card.

VIDEO TAPE DUPLICATION

The mechanics of video tape duplication are described in this edition of SCAN, a four-page newsletter. Mfr: Memorex.
Circle 93 on R.S. Card.

COAXIAL CABLES

A one-page data sheet describes coaxial cables and give a list of the RG equivalents available. Mfr: Ad-dington Laboratories.
Circle 94 on R.S. Card.

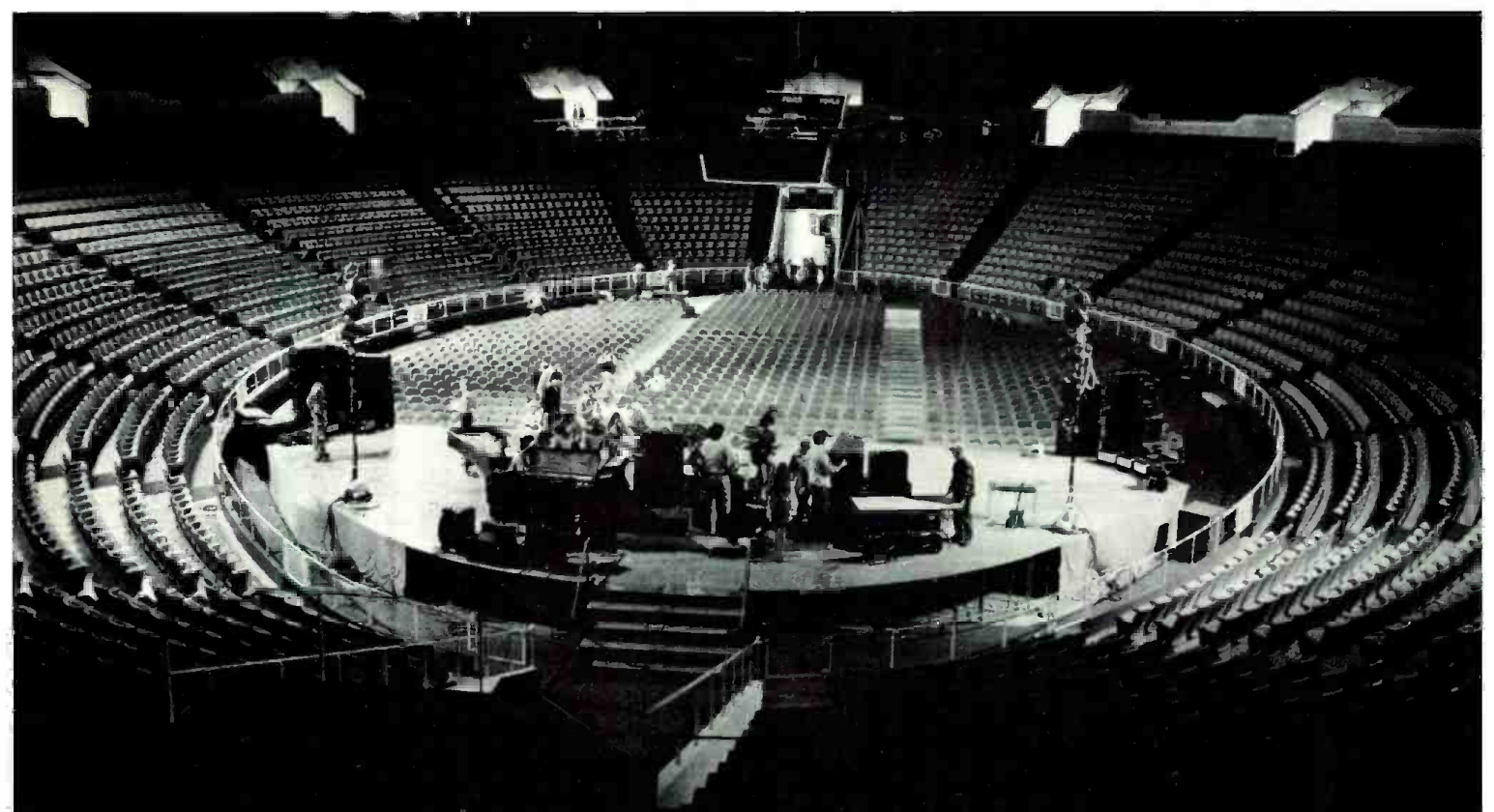

Montreux Casino The Midnight Special Oral Roberts University

Sound Systems by Kustom

Mabee Center at ORU, NBC's Studio 4 in
Burbank, the 1975 Montreux Jazz Festival.

Kustom.

Handmade electronic assemblies
coupled with premium Electro-Voice horn
drivers and speakers.

Professional consultation throughout all
phases of planning and construction—coupled with
the kind of service it takes to keep the largest hall alive
with clean, controlled Kustom sound.

When sound is everything . . . *Kustom*[®]

Chanute, Kansas 66720

Visit booths 115 and 116 at the AES Convention.

Circle 18 on Reader Service Card

www.americanradiohistory.com

Soundcraftsmen

"TOTAL-SYSTEM" EQUALIZATION AIDS

NEW FULL-SPECTRUM 18dB
LEVEL CONTROLS; LED's
for ZERO-GAIN and OVERLOAD
MONITORING; 1dB MARKINGS



Soundcraftsmen
SPECTRUM/BALANCED OCTAVE EQUALIZER
PROFESSIONAL TWIN-GRAPHIC MODEL TG 2209-600

NEW 1/3 OCTAVE PINK NOISE
INSTRUCTIONAL TEST
RECORD for OCTAVE-WIDE
ENVIRONMENTAL SET-UP



FOR THE STUDIO



600-OHM BALANCED IN/OUT

FOR THE ROAD



SG-2205-600 less case — \$399.50

GUARANTEED SPECIFICATIONS

FREQUENCY RESPONSE: ± 0.25 dB 20 to 20,480 Hz
at zero setting.

THD: Less than .05% at 1 volt.

SIGNAL-TO-NOISE: Better than 90 dB.

INDIVIDUAL OCTAVE-CONTROL RANGE: Minimum
 ± 12 dB (Typ. ± 14 dB), each octave centered at 30,
60, 120, 240, 480, 960, 1920, 3840, 7680, and
15,360 Hz.

CIRCLE SERVICE CARD # OR WRITE TO:

SOUNDCRAFTSMEN

1721 NEWPORT CIRCLE, SANTA ANA, CA 92705

db theory & practice

NORMAN H. CROWHURST

• Perhaps nowhere in the whole of audio is the problem of reconciling theory and practice as difficult as in the testing and standardizing of loudspeakers and microphones. Taking the frequency response, and measuring the linearity of an amplifier or other electronic part of a system is relatively easy. It's not by any means as simple as it may sound, but is relatively easy, compared to trying to do the same thing with loudspeakers and microphones.

Back in the early days, scientists established that the subjective impression we call sound is related to the physical phenomena of acoustic waves, designated by frequency and sound pressure levels. Frequency determines the pitch of the sound we hear, on a logarithmic scale, so that doubling frequency corresponds to an octave change in pitch. Sound pressure level, or the pressure fluctuations in the acoustic wave, determines the apparent loudness, also on what appears to be an approximately logarithmic scale.

FLETCHER-MUNSON

Those well known researchers, Fletcher and Munson, were responsible for some extraordinary experiments back in those very early days. What makes them extraordinary is how well they have held up as later experimenters, with far superior equipment, have repeated the tests, giving results that are very close to those of Fletcher and Munson.

Those who were fortunate enough to attend the workshops at Brigham Young University, at which I have been guest lecturer for the last two years, have had the experience of meeting one of these remarkable men, Dr. Fletcher. Although he is now an octogenarian, he still demonstrates why he was able to do something that many of today's engineers would find impossible, limited to the equipment he had in those days.

His measurements were subjective—related to the impression of loudness conveyed by acoustic waves of various intensity and frequency variations. The measurements we started to discuss at the beginning of the column are objective, which means they should be much easier to make. But are they really?

Getting back to the comparison of measurements on purely electronic elements, such as amplifiers, with those on transducer elements, such as

loudspeakers and microphones, the early research assumed that two kinds of measurement would tell the whole story—based on frequency response and amplitude response.

FREQUENCY RESPONSE AND AMPLITUDE RESPONSE

Frequency response determines whether an equal stimulus at any frequency produces a corresponding output. The theory is that if it does, then the content of sound waves reproduced will be as identical at the output as at the input. Amplitude response can have two connotations. It can refer to the question of whether changing the amplitude of a frequency at the input will produce a precisely corresponding change in amplitude at the output. It can also refer to whether, on an instant by instant basis, rather than as an overall thing, amplitudes at the output correspond with those at the input. If they do not, this results in waveform distortion; the output wave is not the same shape as the input wave.

How important is a change of wave shape? Of itself, it may or may not be important. That depends on whether the change is due to a fluctuation that can be heard or not. The ear cannot hear wave shapes. It works much more like a wave analyzer—but not exactly the same—in that its response is determined by the frequencies present, rather than the wave shapes.

If you synthesize a waveshape from two frequencies, say a fundamental and just one of its harmonics, it is easy to show that shifting a phase of one relative to the other completely changes the waveshape. For a long while, people argued whether it was possible to hear such a shift in relative phase.

If the time difference represented by the phase change is significant, then you can hear it. But phase change per se cannot be audible, for the simple reason that it changes along the path of a wave. As you proceed along the propagation path of a wave, moving along one wavelength of the fundamental will be two wavelengths of second harmonic, and so on through the other harmonics. So at every point of distance, the waveshape will be different from that at every other point. Yet the sound will be the same, if the frequency content doesn't change.

RELATING WAVESHAPE TO MEASURABLE DISTORTION

About amplitude response, many articles have been written, relating changes in waveshape that represent distortion rather than merely phase changes, to various kinds of measurable distortion: harmonic distortion, intermodulation distortion, and so forth. We discuss the effects that such distortions can have on the sound—distortions that are very definitely audible.

The effort with amplifiers and other electronic elements has been to reduce variation in frequency response, and the production of such waveform distortions, to a very low figure. We have commented previously on why it was at one time that any distortion less than 5 per cent was inaudible, while later we find distortions much less than that becoming quite objectionable.

There are two reasons for this. First, the early measurements were made with loudspeakers, or headphones, whose distortion was around 5 per cent. So if the amplifier produced less than that, you could not hear it, because the transducer distortion swamped it. Second, we must consider the order of distortion. On a single-frequency fundamental, 5 per cent of second harmonic is not too noticeable,

If you add 5 per cent of pure second harmonic to pure fundamental, you can hear the change in tone quality as you make the change. But if you compared them without making an abrupt change, you would have difficulty telling whether the second harmonic was present or not; it would sound like the same note, and pretty much like a pure sine wave, either way.

After going through all this, and a lot more, amplifier designers and testers realized that even if you make the amplifier perfect, as measured by frequency response and distortion, it does not necessarily sound that perfect when it is used on program material that represents some kind of sound that we normally listen to rather than pure sine waves.

This was then said to be due to the defective transient response of the amplifier. So designers went after square wave testing, tone burst testing, and so forth, in an effort to "measure" transient response. But transient response is not easy to measure, using the same terms of reference we use for frequency response and distortion.

All those tests are made under what we call "steady state" conditions. We

feed in a steady signal of carefully controlled composition, and measure what comes out. Transient response relates to the way the output changes, as the input waveform is made to change, over time.

MEASUREMENTS IN TRANSDUCERS

If this is a problem with electronic items, it is multiplied many times over, when we get into transducers. In electronic components of the system, the output is usually related to what is happening at the input to that component, at that instant and, to a much lesser extent, to what has been happening immediately before. By immediately before, we are talking about microseconds, maybe a few milliseconds.

Also, output and input are measurable in relatively simple terms, as variations in voltage or current, related to one another by an impedance value, which may vary with frequency. At any instant, voltage and/or current is either positive or negative with reference to its neutral, or quiescent value, and has a simple numerical value at that instant.

As soon as we start releasing the same energy represented in these electrical signals in the form of a

sound wave, it becomes a much more complex thing. Broadly speaking, voltage converts to sound pressure, and current converts to air particle movement. We say "broadly speaking," because even that conversion is incomplete, not always true—sometimes it can be *vice versa*—and there are other factors to consider, so we will not attempt to go into all this in one column.

SOUND PRESSURE

Sound pressure at a point depends on the cumulative effect of air particle movement to and from that point, in all the various possible directions. In simple, fully expanded sound wave propagation, the form is known as *longitudinal*, which means that air particles move back and forth along the direction in which the wave is travelling, for example, away from the loudspeaker.

But it is always much more complicated than that. If you use a paddle to propel a boat through water, have you ever looked at what happens to the water? You push the water backwards with your paddle so the boat will move forward. But as you withdraw the paddle, you will notice little eddies in the water, caused by the paddle. These happen in sound waves

COMMERCIAL DUPLICATING SYSTEMS

INSTALLATION AND PREVENTIVE MAINTENANCE TRAINING INCLUDED IN PRICING

Southeast Regional Service Center
TECH SYSTEMS

2080 Peachtree Industrial Ct., No. 107
Chamblee (Atlanta) GA 30341
Phone (404) 457-0426



Circle 20 on Reader Service Card

theory & practice (cont.)

too, but in much more complicated fashion.

The surface of the water has only two dimensions. The air through which sound waves propagate has three dimensions. Do you begin to see how it can get complicated?

HOW TO TEST SPEAKERS AND MIC'S

So how are we to test loudspeakers or microphones? In essence, what we would like to do—and many fondly

imagine they have done it—is to make all the elements except the one we want to measure, perfect, so what we measure is the defects in the item being measured.

In today's world of electronics, this is easy. Instruments with digital readouts can measure whatever quantity we want measured—voltage, current, time, frequency—to whatever order of accuracy we fancy. We then know that what we have measured is correct, to that order of accuracy, which can always be adequate.

Suppose now that we want to measure a loudspeaker's performance in

the same way we measure an amplifier's performance. We want a perfect microphone and both the loudspeaker and microphone in a perfect environment, so that what we measure will be just the response of the loudspeaker. We can come close to the perfect microphone, it is true. At least, their performance has been measured, so that, even if they are not perfect, we can apply a calibration curve to correct for any inaccuracies.

But the perfect environment—that would be an anechoic room, right? How good do you think an anechoic room would be? Supposing that it is perfect, will taking a set of frequency responses in various directions from the loudspeaker tell you how that component will perform on, say, a musical program?

When we get through by that method, we have overlooked transient response completely. And subjectively, anyone who has worked in the field will tell you that two loudspeakers whose frequency responses look close to identical, will not sound as near to identical as their responses look, necessarily. They may or they may not.

Of course, keeping distortion low in speakers is important, for the same reason it is in amplifiers and other items of electronic equipment. So such measurements should be made. There is no substitute for them, to determine whether these effects occur, and how much, if they do. Possibly we need more sophisticated tests to get precise measurements of even this form of distortion than are needed for electronic components.

But then comes the question of frequency response. When we listen to a loudspeaker reproducing program material, what do we hear? We do not listen in an anechoic room. If you've ever tried it, you'll know why—it's horribly unnatural. We listen in a "live" room—one that adds its own characteristic reverberation.

But it has been established that we hear the reverberation separately from the original sound. More precisely, perhaps we should say that our auditory faculty interprets the reverberant component separately from the direct sound, because the fact is, our ears pick up every component of sound going into them.

To date, no microphone has that capability. So to make a meaningful test, we need to derive a way of making the separation that is feasible with test equipment available to us. How would you go about that? We'll take that up in our next issue. ■

NAB BOOTH 507

Spotmaster[®]

CONSOLES

THE VERSATILE ONES

FULL RANGE OF MODELS FOR PRODUCTION, ON-AIR, REMOTE BROADCAST, CATV AND CCTV USE

- 4 BEV-50 Versa Consoles – The ultimate compacts with large console features. 4 mixers, 10 inputs and both line and PA outputs.
- 50 Series Mono and Stereo – Quality 4 mixer consoles with full cuing, muting and monitor features.
- 100/200 Series Mono and Stereo – 5 or 8 mixers, switchable inputs, low noise FET switching and dual channel operation with many other features for your studio.
- Series 3006 Slide Type Mono and Stereo – Versatile slide type consoles with 10 mixers, dual channel operation and intercom features.
- Series 4006 Modular Mono and Stereo – Advanced design completely modular slide consoles with plug-in electronics and input modules. Unique features including cuing without disturbing preset levels.

BROADCAST ELECTRONICS INC.

– A FILMWAYS COMPANY –

8810 BROOKVILLE ROAD
SILVER SPRING, MD. 20910
PHONE: 301-588-4983
TWX: 710-825-0432
CABLE: "SPOTMASTER"

ALSO CARRY
MACHINES,
AUDIO
PROCESSORS
AND STUDIO
ACCESSORIES



Circle 22 on Reader Service Card

Silent Partners

If you are involved in the business of professional tape recording, we have an interesting proposition for you.

A couple of silent partners who will work day and night, assure excellent results, let you maintain full control and be unfailingly reliable.

They are the new Revox A700 tape recorder and the Beyer DT109 microphone/headphone combination and both of them come with excellent credentials.

The Revox A700 is the most recent addition to the Revox line which already includes the critically acclaimed A77, a machine which was described by the *Stereophile Magazine* as "unquestionably the best tape recorder we have ever tested."

Of the new Revox A700, "Tape Magazine" says, "We could find no fault with the Revox A700 and fully accept the maker's claim that it bridges the gap between the home and the recording studio." Listening to tapes made on the new Revox A700 is a revelatory experience. Tape hiss is virtually non-existent. The music seems to emerge from a background of velvety silence and at 3¾ ips the absence of extraneous noise is truly startling.

As for the Beyer DT109 microphone/headphones, they are in a class by themselves. Highly sensitive and capable of withstanding immensely high sound pressure without overload or distortion, they feature modular

construction with a unique multi-pin plug in lead allowing separate wiring of left and right headphone channels, independently of the microphone.

Add featherweight comfort and effective ear sealing together with a wide frequency, true cardioid, broadcast quality microphone specially designed to work under extremes of temperature and humidity, and it is easy to understand why the DT109 has become so popular for live remote broadcasting, studio, film, television, disc jockey and language laboratory applications.

Together or separately, our remarkable silent partners could open you ears to recording and broadcasting possibilities you never knew existed.

Your nearest Revox professional/Beyer dealer will be delighted to arrange an introduction.

We think once you have met them you will wonder how you ever did without them.



Illustrations may contain optional extras.

Revox Corporation
155 Michael Drive, Syosset, N.Y. 11791

Please tell me where I can see and buy Revox good used machines*
 Revox A700
 Revox A77
 Beyer DT 109

Name _____
 Address _____
 City _____ State _____ Zip _____

BS12 *AS AND WHEN AVAILABLE FROM OUR DEALERS

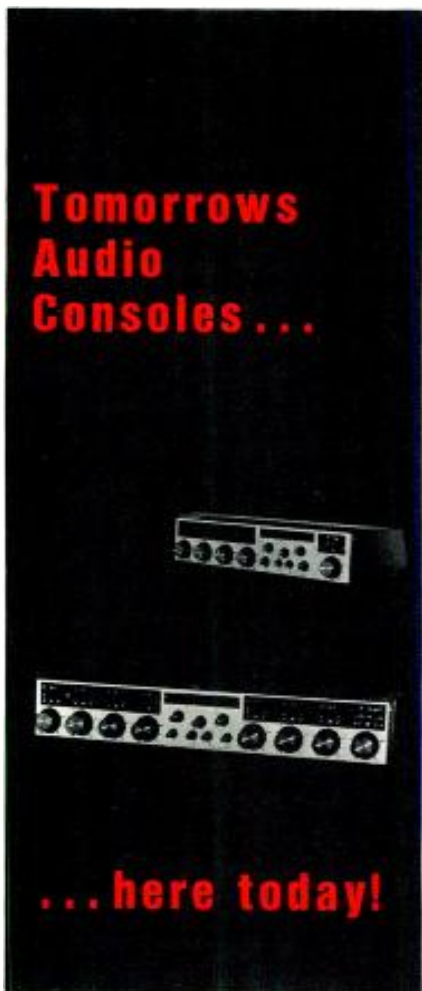

Tomorrows
Audio
Consoles...

... here today!

The biggest advance of audio control in the last 15 years.

Totally DC controlled for noiseless switching and audio mixing. Lighted touch pad switching eliminates mechanical noise and breakdown. Advanced solid state light emitting "VU" meters. Cermet mixers and level controls for years of trouble free operation. Plug in amplifier cards. Full range input gain select from mic thru high level. All inputs and outputs balanced. Distortion — 0/3%; Response — +0, -2 db, 20 Hz - 20 KHz; Noise — -65 db (mic inputs). Flexibility? Complete complement of accessories for input expansion, equalization, remote control, etc.

10 day free trial and 2 year warranty.

Call collect or write today. You'll find it both an exciting and profitable adventure!

Models & Prices

SC-5M Single Channel, mono	\$ 605
DC-5M Dual Channel, mono	\$ 742
DC-5MS Dual Channel, stereo	\$ 979
DC-8M Dual Channel, mono	\$1,199
DC-8MS Dual Channel, stereo	\$1,760

RAMKO RESEARCH

3516 C LaGrande Blvd.
Sacramento, California 95823
Telephone (916) 392-2100

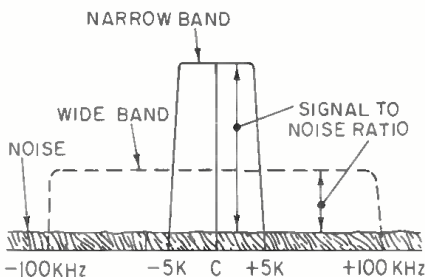

Figure 1. Noise amplitude remains constant. Broadbanding reduces gain and the signal/noise ratio suffers.

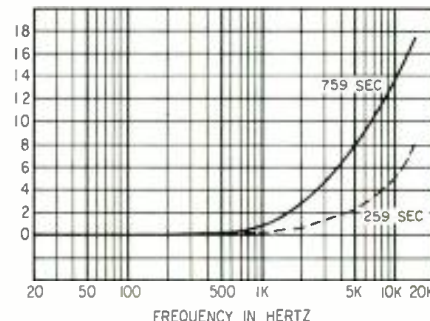

Figure 2. Comparison of the 75 μ sec and the 25 μ sec pre-emphasis curves.

• Now that the Dolby® B Type noise reduction system has been approved by the FCC for use on f.m. broadcast transmissions, questions have arisen in the minds of many as to what it is all about. There are many in the recording as well as in the broadcast industries who are familiar with the Dolby A system and its function in tape recording processes, but not sure about the problems involved in its use over the f.m. system. Other questions arise at individual stations as to what benefits a particular station can derive from the use of Dolby B.

CLARIFYING THE FCC RULE

Much confusion arose when the FCC approved use of the B system on f.m. So much, in fact, that the FCC had to release its own clarification. In a nutshell, it said this: 1) The 75 μ sec pre-emphasis time constant is still required. 2) The Dolby B system may be used if desired. Its use is purely optional and is classed as any other processor, such as a peak limiter or agc amplifier. 3) There are two restrictions. When in use, the complete system must be used. It is not permissible to change the pre-emphasis to 25 μ sec alone; the Dolby expansion must be in use at the same time. And, during annual Proof of Performance, the unit must be bypassed or disabled and the standard 75 μ sec time constant used for the measurements.

THE BASIC PROBLEM

Noise afflicts all electronic systems and especially audio and rf transmission systems. In this instance, the particular concern is noise in the f.m. receiver. Noise at the receiver may be of many types, either atmospheric or man-made, riding in on the carrier.

A very definite limiting factor on receiver performance is its own internal noise. Much of this is due to the movement of electrons through components, conductors, etc. This noise is reasonably constant in amplitude and covers a very wide spectrum, and is not readily tunable. The receiver front end, and particularly the first stage, is the most critical area and it is where the basic s/n ratio of the set is determined. To overcome this requires carrier signal level and wide deviation for the audio sections. The noise figure remains somewhat constant, so the improvement must come by increasing the signal itself. Some factors, such as broadbanding, which must be done to the f.m. set, work against this. Broadbanding reduces the gain and the sensitivity.

There are also noise sources we cause by other processes. Tests have shown that the s/n ratios become worse by about 20 db when a stereo sub-carrier and its components are added, and more deterioration when an SCA channel is also added.

PRE-EMPHASIS

When the f.m. system itself was first approved back in the 40's, some of these noise factors were known. It was also known that the actual energy distribution across the audio band-pass that could be produced by the equipment of the time had a severe rolloff of the high part of the curve. It was one thing to prescribe a wide band audio system, but yet another when it came to producing it. With enough care, amplifiers and other parts of the system could pass 15 kHz, but the microphones could not, nor could the disc recording and reproducing equipment. Tape equipment didn't exist—the infant was using a spool of wire. The net result was that

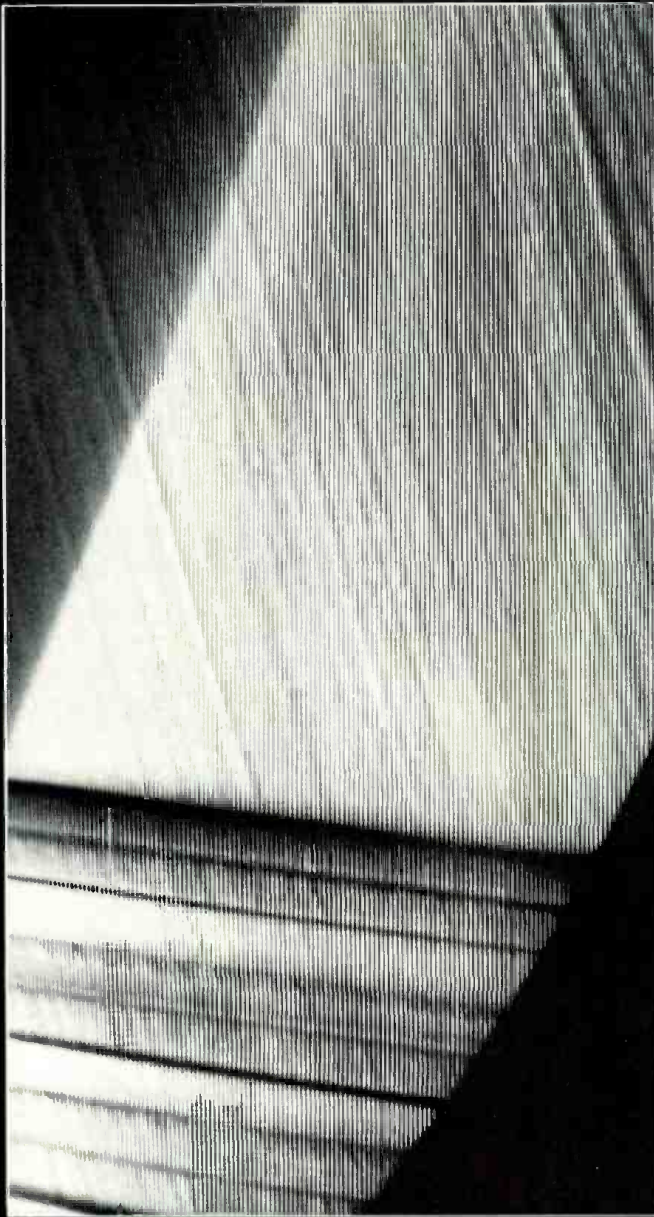

Master from Transco Products Corporation



Master from Audiodiscs® by Capitol®

Your eyes are now a cutting stylus.

And with Audiodiscs® they've just cut a perfect master.

The Audiodiscs® master disc by Capitol is magnified 200 times as is the master from Transco Products Corporation. As this close-up reveals, there is a remarkable difference between the two. Even more exciting is the fact that these differences didn't exist 6 months ago.

What caused this remarkable superiority? Since early 1975, Audiodiscs by Capitol have been manufactured in the newest and most advanced disc plant in the world. All aspects connected with the manufacturing process, including cleanliness, have been optimized to

produce a superior master disc. With absolutely no compromise. This is apparent in the coating process where the exacting application of lacquer ensures a smoother disc.

At this point, look at the pictures again... they speak louder than words.

For a free sample and brochure, write on your company letterhead, or call Harry Preston at (213) 462-6252.

**AUDIODISCS® A PROFESSIONAL PRODUCT
MANUFACTURED BY THE SAME PEOPLE THAT MAKE
AUDIOTAPE® AUDIOFILM™ AUDIOPAK® BROADCAST
CARTRIDGES, AND THE LEARNING TAPE™ BY CAPITOL.**

audiodiscs

BY CAPITOL®

Capitol™ CAPITOL MAGNETIC PRODUCTS A DIVISION OF CAPITOL RECORDS, INC. 1750 NORTH VINE STREET, LOS ANGELES, CALIFORNIA 90028

Circle 23 on Reader Service Card

Audio Distribution ...

... made easy!

Six different audio DA's designed to solve all of your distribution problems.

From our table top 1 in/6 out to our powerful 20 in/80 out. Stereo or mono operation, output metering, individual level controls and balanced inputs and outputs are just a few of the many features found in these superb DA's. Performance? Response — 10 Hz - 20 KHz ± 0.5 db; Dist. — 0.1%; Output level — +20 dbm max; Signal/Noise — -90 db; Channel separation — 80 db. Quality? All RAMKO products are backed by our 10 day free trial and 2 year warranty. They have to be good to do that.

Call collect or write today!

Models & Prices

DA-6/E 1x6 (table top)	\$ 145
DA-6R/E 1x6 (rack)	\$ 165
DA-6BR/E 1x6 (rack, indiv. cont.)	\$ 179
DA-6RS/E 2x12 (rack)	\$ 239
DA-16BR/E 2x16 (rack, meter, etc.)	\$ 295
DA-2080 up to 20x80 (rack)	\$325 - \$1,675

RAMKO RESEARCH

3516 C LaGrande Blvd.
 Sacramento, California 98523
 Telephone (916) 392-2100

Circle 31 on Reader Service Card

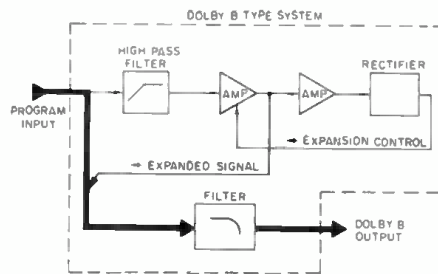

Figure 3. Simple block diagram of the Dolby system.

the upper audio frequencies rolled off severely. To help counteract this and to combat the receiver noise factor, a 75 μ sec pre-emphasis time constant was prescribed. This time constant gives a boost of up to 17 dB at 1.5 kHz.

Over the years, considerable improvement has been made in microphones, disc and tape recording equipment and processing techniques, so that today there is a considerable amount of high frequency energy in the program material. Several independent studies here shown that the energy distribution now rolls off only about 6 to 8 dB at 15 kHz. The 17 dB boost of the 75 μ sec. pre-emphasis is far too much. The rolloff is more nearly like a 25 μ sec. de-emphasis curve.

SPECTRUM ANALYZERS AND STEREO

This was the situation until a few years ago when two things happened: spectrum analyzers were developed and stereo was approved. FCC inspectors began using the analyzers and, lo and behold, they discovered that almost every f.m. station was out of tolerance on modulation—some were far in excess of 150 per cent instead of 100 per cent, although the modulation monitors in most of these stations did not indicate excursions higher than 100 per cent modulation. Many citations were sent to stations by the FCC for violating the rules with overmodulation.

REDUCING OVERMODULATION VS S/N LOSS

F.m. stations faced a dilemma. To prevent overmodulation on the high frequencies it was necessary to pull back the modulation of the low frequencies to somewhere like 35-40 per cent modulation. But lowering the modulation percentage in this manner also reduced the deviation of the carrier and this affected the signal-to-noise ratio in the receiver about 6 to 8 dB. Further, if stereo was already in use, the s/n ratio had already suffered over 20 dB loss.

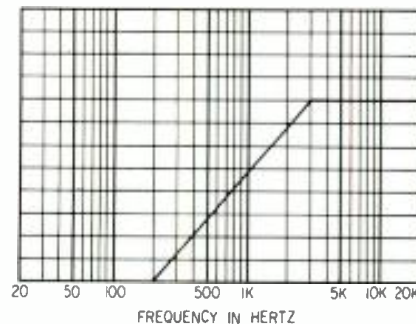

Figure 4. The low frequency skirt of the side channel high pass filter is a ramp rather than an abrupt skirt.

To get the deviation back up and still not overmodulate, greater use of signal processors were used and very heavy amounts of compression and peak limiting. As a further guard against overmodulation, peak clipping was used. All this processing did make a louder signal, especially in the fringe areas, but it also eliminated most of the dynamic range and the clippers introduce some distortion.

DOLBY B

The Dolby B Type system as used on f.m. is similar to the A system employed for tape, but less complicated. The basic concept is fairly simple. The program is routed through the unit in a feed-through manner. Part of the signal is tapped off into a side channel, going through a high pass filter where expansion takes place on the upper band frequencies. The control of this expansion is done by these frequencies themselves rather than the low frequencies, as is the case in most expanders.

The low frequency skirt of this filter is not abrupt, but is more of a ramp starting at about 200 Hz to 4 kHz. All signals above 4 kHz are passed equally, but those on the ramp with varying degrees. The expansion takes place in a similar manner with varying degrees of maximum that can be obtained on the ramp, up to 10 dB above 4 kHz. This is a controlled expansion; only the very low amplitude signals receive the greatest expansion, while higher level signals in the filtered area receive less or none. After passing the filter, these expanded signals are added back to the main channel audio. The combined audio now passes through another filter arrangement that rolls off the high audio frequencies in a fixed manner so that the resulting curve, when combined with the 75 μ sec curve in the transmitter, effectively reduces the overall system time constant to a 25 μ sec curve.

THE RECEIVER

To obtain the greatest benefit from

Capitol Records Tests, Calibrates, Evaluates, Approves, Repairs, Quality Controls, and Reviews with the Stanton 681 Cartridge Series

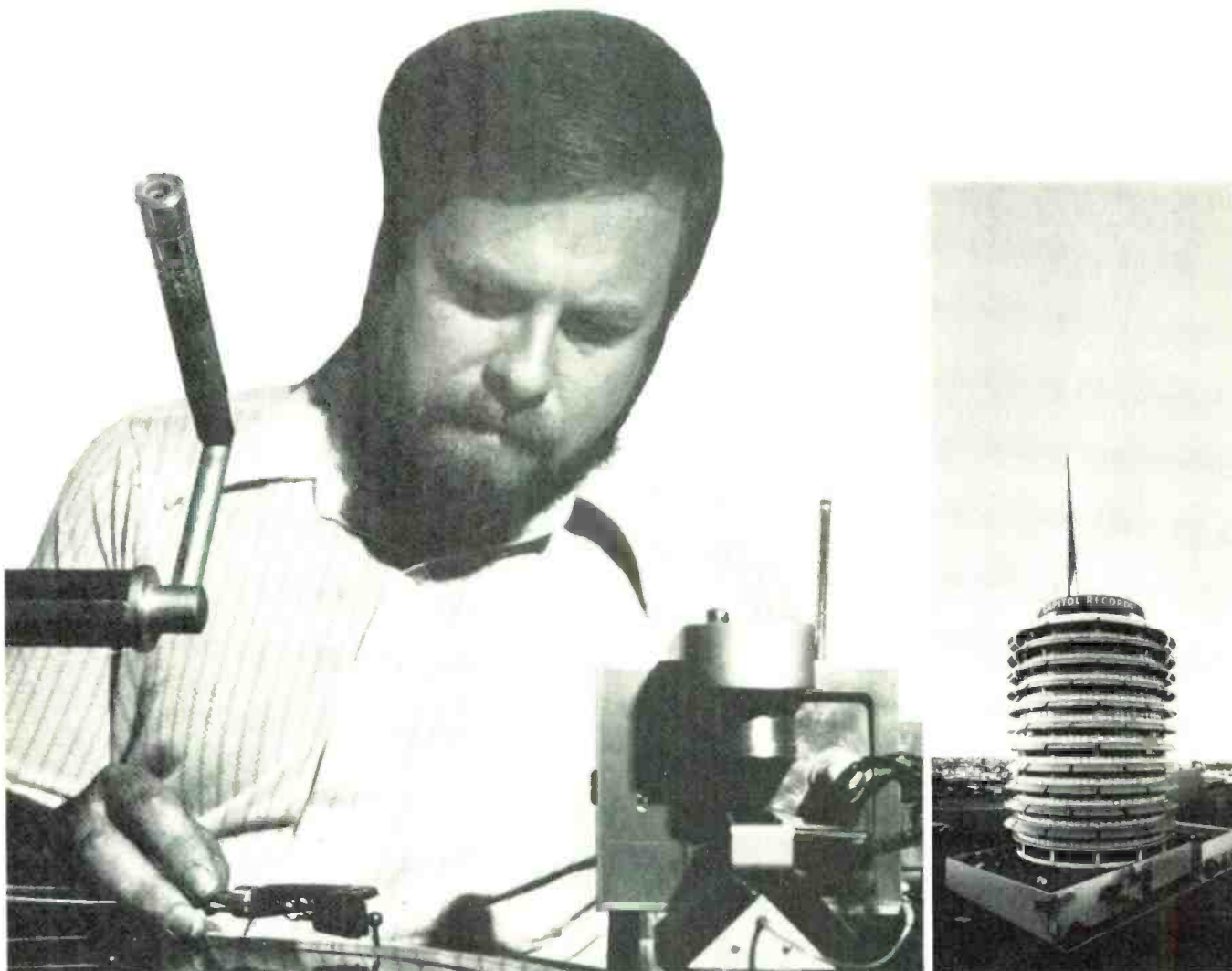

The physical process of making phonograph records is not for amateurs. It is a job for craftsmen of the highest order, craftsmen who know exactly what they are doing. Naturally, they need the precisely right tools to do the job.

In the case of Capitol Records, the highest quality tools are employed throughout the process. That is why Stanton 681 Calibration Standard Series Cartridges are used, with various styli that are designed specifically for each critical measuring and listening job.

It has proven to be a great advantage to Capitol Records to standardize their entire operation with the 681 Series and three basic styli:

The D6807A — for cutting system check-outs.

The D6800EEE (our famous Triple-E) — for the most critical listening.

The D6872AMC — for tough nickel-plated "mothers".

The Stanton 681 Calibration Standard Series enjoys almost universal acceptance throughout the Recording Industry. After all, it

was created in order to satisfy the need for a cartridge of sufficient sophistication to be used as a primary Calibration Standard in system checkouts for linearity and equalization. Stanton Magnetics met this need by producing an "absolute" cartridge standard . . . stereo cartridges of such linearity and overall quality as to gain immediate acceptance within the Recording and Broadcasting Industries.

The fact that Capitol has selected the Stanton 681 Calibration Standard Series for use throughout the operation is a testament to its quality.

All Stanton Calibration Standard Cartridges are guaranteed to meet specifications within exacting limits. Their warranty comes packed with each unit. . . The calibration test results for that individual cartridge.

Whether your usage involves Recording, Broadcasting or Home Entertainment, you can enjoy professional audio quality with Stanton Products.

For further information, write: Stanton Magnetics, Inc. Terminal Drive, Plainview, N. Y. 11803.

Circle 45 on Reader Service Card





**MEASURE
REVERB TIME
IN REAL TIME.
Instantly!**

RT-60.

This easy-to-use instrument delivers precise

reverb time measurement in instant real time digital read-out. No more chart recorder or time-consuming chart recorder analysis. The RT-60's integrated circuitry incorporates a one-third octave band pass filter system with frequency centers on 250,500,1000,2,000, and 4,000 Hz. It operates on self-contained ni-cad batteries. Mounted in a rugged carrying case, the RT-60 weighs only 3.5 pounds. The dealer net cost, FOB San Diego, is just

\$460.

Write for your free technical bulletin on the RT-60 — instantly!

**COMMUNICATIONS
COMPANY
inc.**



3490 Noell Street
San Diego, CA 92110
Telephone (714) 297-3261

Circle 29 on Reader Service Card

**The
R.A. Neilson
Company.**

MARKETING SERVICES FOR
THE PROFESSIONAL AUDIO
AND VIDEO INDUSTRY.

- Consultation • Advertising •
- Sales Promotion • Research •
- Industrial Design • Technical
Writing • Personnel Search.

A technically oriented
Full-Service Agency.

5001 Laurel Grove Ave.
No. Hollywood. Ca. 91607
(213) 760-2010



Circle 30 on Reader Service Card

the Dolby process, the receiver should be equipped with a decoder. This unit will route the audio through a 25 μ sec de-emphasis network and then to a compressor, which will restore the original dynamic balance.

A receiver without the decoder will have a 75 μ sec de-emphasis and this will add a more severe rolloff of the audio signal. The tone control may need some adjustment, but this depends upon the particular receiver. Counteracting this rolloff is the boost given the upper audio signals by the Dolby expander.

THE FRINGES

On the local scene, the station that used lower modulation can now increase this to 100 per cent and will sound as reasonably loud as the station that uses heavy compression.

But the greatest benefit shows up in the fringe areas. Remember that the s/n ratio also depends upon deviation. A receiver with a decoder can realize more than 10 db improvement in the noise figure. The receiver without a decoder will still realize 6 to 8 dB noise improvement from the station that has increased its deviation to 100 per cent modulation. There

will also be the benefits of the expanded high audio frequencies.

But in the fringe areas, other factors besides receiver and atmospheric noises can be present. With the f.m. band becoming so crowded with signals, interference can be a greater problem than noise. Such interference may completely override any benefit gained by a better noise factor.

FORMAT

Program formats and the way a station operates are determining factors in the net results that can be realized. The station with a top 40 format, using very heavy compression so that the modulation meter hangs right up there may be entirely satisfied with the results from the present equipment investment. However, it can achieve some of these same results, and more dynamic range by the use of B Type Dolby. The station with a good music format or a classical format that uses low dynamic range and only very modest amounts of peak limiting, can gain the most by achieving full modulation levels without overmodulation while still retaining the dynamic range.

Many stations today with a variety of formats from top 40 to classical, are using the Dolby B.

LIMITERS

Theoretically, the station should be able to modulate to 100 per cent across the bandpass without the use of limiters and without overmodulation. But in practice, some peaks do get through. Consequently, peak limiters are inserted between the Dolby and the transmitter, and if desired, clippers may still be left "on guard" to prevent positively any overmodulation.

SUMMARY

The Dolby B Type system is an alternative method that expands the high audio frequencies and effectively reduces the transmitter time constant to 25 μ sec. The system is not a cure-all; all stations (and listeners) will not derive its full benefits. The basic problems are receiver noise in the fringe areas (where interfering signals are not the main factor) and the processing methods used at the station to improve the receiver noise problem. Effectiveness depends upon station format, method of operation, and interference in the fringe areas.

**THE COMPLETE REFERENCE
Sound System
Engineering**

**JUST PUBLISHED—EVERYTHING
YOU NEED TO KNOW TO TAILOR
SOUND SYSTEMS TO
SPECIFIC REQUIREMENTS.**



- Includes:
- Audio Systems
 - Decibel Notation System
 - Loudspeaker Directivity and Coverage
 - The Acoustic Environment
 - Designing for Acoustic Gain
 - Interfacing Electrical and Acoustical Systems
 - Installation, Equalization, Instrumentation, Specifications
 - 295 pages

db The Sound Engineering Magazine
SAGAMORE PUBLISHING CO.
1120 Old Country Road
Plainview, New York 11803

Please send me _____ copies of
SOUND SYSTEM ENGINEERING
(21156). I have enclosed \$19.95 + .50
postage and handling. Add sales tax
where applicable.

Name _____
Street _____
City _____ State _____ Zip _____



• Every year around this time, **db** likes to perform some little extra service for its readers. This year, we are pleased to bring you a glossary of all the terms you need to know in order to become an instant recording engineer. Once you've mastered this list, it will no longer be necessary for you to think about going to school to learn the recording business. I know this to be true, since when I showed this glossary to the faculty of the Institute of Audio Research, they said that I should seriously think about getting out of the teaching business. What more proof do you need?

Unfortunately, the glossary is not in alphabetical order, since the editor's guide to the A-B-C's has been stolen, no doubt by someone from a rival magazine.

Complex Wave—a method of attracting the attention of a musician when the cue system is broken.

K—A Correction Factor, permitting the instant solution of any engineering problem. For example, let:

T = the answer you need

F = the answer you get

then $K = T \pm F$

transposing, $T = F \pm K$

From the formula, it can be seen that K turns any and every wrong answer into a right answer. Often called the *Phinagle Factor* by graduate engineers.

Logic Circuit—A system whose circuitry cannot be described intelligently by anyone, including its designer.

Quality Control—A department that enables people with hearing impairments to work in the recording industry.

Standard—Your employer's method of doing things.

Non-standard—Everyone else's method.

Mono—A mild form of hallucination, in which the patient thinks he hears music coming out of a box.

Stereo—A more serious disorder, in which the patient hears mono coming from a point between two boxes.

Quad—Terminal mono.

Infinite Baffle—A writing technique, used in the preparation of tape recorder service manuals.

Isolation Amplifier—In a console, an amplifier whose output terminals cannot be located.

Automated Mixdown—a process where all errors of judgment made during a mixing session may be stored on tape, thus limiting the number of tracks that may be used during recording, thus limiting the need for automated mixdown.

Breathing—In a darkened studio, a noise that lets you know the vocalist is still available for recording.

Band Reject Network—The A & R department.

Bulk Eraser—A system for erasing bulks.

Third Octave Filter—A filter that removes every third octave.

Threshold of Pain—The point at which the listener begins to experience physical discomfort. May be measured by playing Donny and Marie Osmond records.

Bucket Brigade System—Fire fighting method in a low budget studio.

Scoring Session—A post-session activity, involving standard, though non-technical, procedures.

Fret—Worrying about scoring.

Flaking—Nervous condition, brought on by a fear of erasing the string tracks.

Hydrophobia—A fear of echo return lines.

Coincident Pair—Two groupies showing up for a scoring session.

Fail-safe System—In a tape recorder, a system that automatically destroys the tape whenever the operator depresses the wrong button by mistake.

Pantheistic—A religious belief in the divinity of the pan pot.

Vented Port—A bottle of wine that was opened on a previous session.

Insertion Gain—Lengthening a session by wasting time patching equipment in and out.

Insertion Loss—Condition occurring when a client refuses to pay for time wasted during insertion gain.

Attack Time—The time it takes to receive a bill for a new piece of equipment requested by a client. Measured in microseconds.

Release Time—The time it takes for a client to pay for a session during which a new piece of equipment was used. Measured in fiscal quarters.

Acoustic Cancellation—The effect noted what a guitar player finds a better paying gig.

Clear-Com
'communication in every event'

WRITE OR CALL FOR DETAILS

Clear-Com
Portable Intercom Systems

759 Harrison Street, San Francisco, Ca. 94107
(415) 989-1130

db April 1976

19

Circle 25 on Reader Service Card



**complete
supplies for
reel to reel
audio recording**

TAPE AMPEX and Scotch
all professional grades
on reels or on hubs

**EMPTY
REELS** all sizes, widths
and hub types

BOXES for all reels, in various colors

LEADER-, TIMING- & SPLICING TAPES

Top Quality Competitive Pricing
Immediate Shipment
Call or Write for our Catalog



recording supply corp.
1291 RAND RD -DES PLAINES, IL 60016
312/297-0955

Circle 26 on Reader Service Card

the sync track (cont.)

Telephone Filter—A protective circuit which prevents musicians from making long distance calls on the studio phone.

Absence—Conditions arising when a presence filter is wired in out-of-phase.

Polar Plot—A scheme by musicians to go into overtime by telling Polish jokes between takes.

Perfect Fifth—An unopened bottle, available for scoring sessions.

Well tempered—Attitude of a producer, on learning of availability of perfect fifth.

Dummy Load—Putting up with the artist's friends, during a vocal overdub session.

Separation—An engineering technique, used for splitting a group of musicians into a collection of isolated noises.

Mixdown Session—An attempt at making a collection of isolated noises sound like a group of musicians.

Negative Feedback—Telling the producer he is a moron after he insists on an attenuation boost of 1,000 Hz at all frequencies.

Zero Reference Level — Engineer's bank balance, after telling a sufficient

number of producers they are morons.

Studio Rate Card—A studio publication, which specifies the fee that the management hopes other studios will demand.

Studio Rate—The current hourly rate, based on an estimate of the client's bank account and gullibility quotient.

Low Noise Tape—Tape in which the print-through partially masks the tape noise.

Low Print Tape—Tape in which the tape noise partially masks the print-through.

Low Noise/Low Print Tape—Tape in which dropouts and harmonic distortion partially mask both the tape noise and the print-through.

Transient Response—The unsolicited reaction of a coffee man who arrives during a playback session.

Critical Damping—Telling the coffee man to keep his mouth shut.

Millhouse Gap Effect—A condition, whereby a previously perfect tape develops long dropouts. The unit of measurement of the Millhouse Gap is the Wood, with 3π Woods = 18 minutes = 1 RoseMary. ■

**A COMPACT
WITH ALL
THE OPTIONS**



The ROBINS/FAIRCHILD Model 659A, REVERBERTRON, is a complete dynamic reverberation system designed to enhance Broadcast/Production or Recording Studio sound.

With solid state electronics and high performance electro-mechanical delay lines in two separate enclosures, the REVERBERTRON is compact in size yet loaded with features. Continuous reverb mix controls, VU metering, selectable decay times, 3 band equalization and remote control . . . to name a few. All in 7" of rack space.

REVERBERTRON! Designed to fit your rack and priced to fit your budget.

FOR COMPLETE DETAILS, CALL OR WRITE SAM JONES.

ROBINS & FAIRCHILD
A Robins Industries Corporation
75 Austin Boulevard, Commack, N.Y. 11725
(516) 543-5200

Circle 27 on Reader Service Card

you write it

Many readers do not realize that they can also be writers for db. We are always seeking meaningful articles of any length. The subject matter can cover almost anything of interest and value to audio professionals.

You don't have to be an experienced writer to be published. But you do need the ability to express your idea fully, with adequate detail and information. Our editors will polish the story for you. We suggest you first submit an outline so that we can work with you in the development of the article.

You also don't have to be an artist, we'll re-do all drawings. This means we do need sufficient detail in your rough drawing or schematic so that our artists will understand what you want.

It can be prestigious to be published and it can be profitable too. All articles accepted for publication are purchased. You won't retire on our scale, but it can make a nice extra sum for that special occasion.



WORAM AUDIO ASSOCIATES

Consultants in Studio Systems
Engineering, Design and Installation

—offering—

**A COMPLETE CONSULTATION
SERVICE FOR STUDIO
PLANNING AND
CONSTRUCTION**

**FREE-LANCE RECORDING
SERVICE IN THE
NEW YORK AREA**

**212 673-9110
64 University Place
New York, N.Y. 10003**

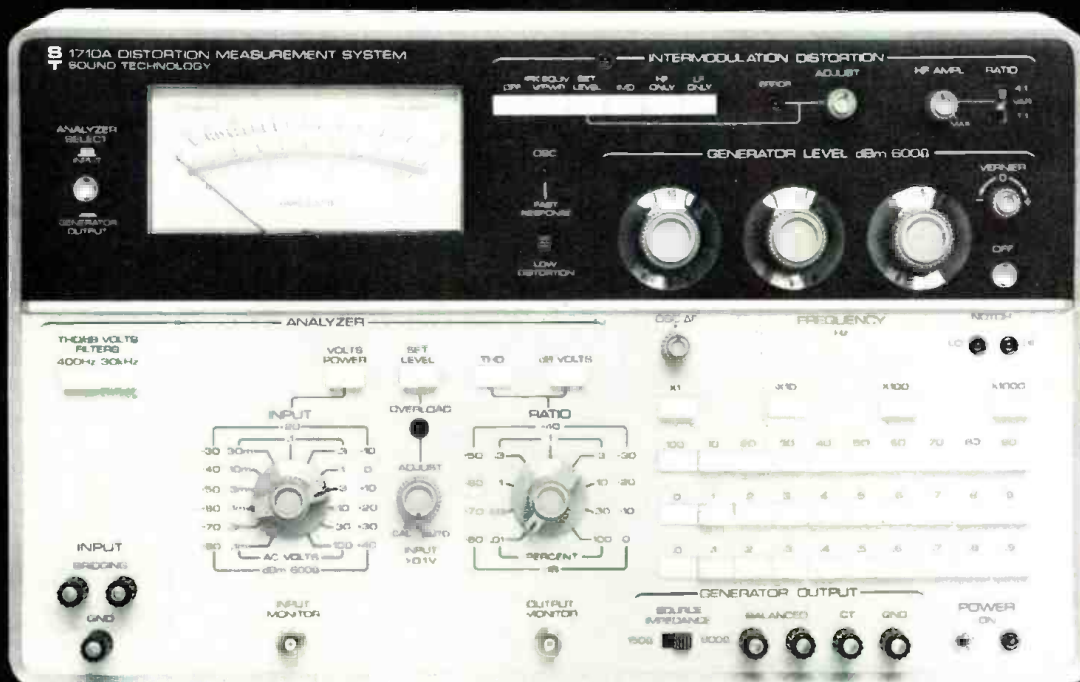

Your new automatic distortion measuring system for balanced measurements

REDUCED OPERATOR ERROR

Here's something you'll like — Sound Tech's new distortion measuring instrument for use in balanced work.

The new 1710A is much more than just a distortion analyzer. It's a system.

It contains its own ultra-low-distortion generator tracked with the analyzer. It's a system that greatly simplifies measuring — gives you fast measuring with simple operation that reduces operator error.

For example, push the frequency buttons and you set both generator and analyzer. Push "Distortion" and you have your reading. Automatically. No slow, tedious manual null-searching.

Features in the new 1710A include:

- a balanced, floating output (600/150 ohms)
- a balanced (bridging) input
- a high-level +26 dBm signal

- +26 to -90 dBm attenuator
- distortion measurements to .002%
- fast 5-second measuring speed
- automatic nulling, optional automatic set level.
- both harmonic and optional intermodulation distortion measurements.

SPECIAL OUTPUT CIRCUIT

In the 1710A you get a transformerless audio generator output that's balanced and floating. No transformer means no transformer distortion. Floating *and* balanced means you can connect to virtually any audio circuit regardless of configuration. And you can set the output from +26 to -90 dBm in 0.1 dB steps.

FAST, SIMPLE MEASURING

Automatic nulling and the automatic set level option (ASL) give you ex-

tremely fast measuring and little chance for operator error. You can measure in 5 or 6 seconds. *With ASL you can measure distortion vs. frequency, and distortion vs. voltage or power without resetting level.*

IM OPTION

An additional optional bonus is that the 1710A also measures intermodulation distortion. After you've made a harmonic measurement, just push the "IMD" button. In 3 seconds you'll have the IM reading. With this option you'll be ready for future IM requirements.

CALL/SEND NOW FOR LITERATURE

It's worth while getting the information on this major new distortion measuring system. Call Larry Maguire or Bob Andersen now and get our new product brochure. It's ready and waiting.

ST SOUND TECHNOLOGY
1400 DELL AVENUE
CAMPBELL, CALIFORNIA 95008
(408) 378-6540

Circle 46 on Reader Service Card

www.americanradiohistory.com

VERSATILE MIXER



• Disko Mix-Master III features head-phone cueing of either channel, pan control for fading from one turntable to the other, and a separate microphone circuit which allows use of either the microphone alone (for p.a. use) or mic over music. In the latter position, the music is automatically reduced by 10 dB for increased intelligibility. A separate microphone gain control is included. The unit is fully shielded to prevent stray pickup and contains its own power supply. The stereo phono inputs are RIAA equalized for magnetic cartridges. Noise is rated at below 0.8 microvolts and distortion below 0.1 per cent THD.

Mfr: Berkshire Audio Products

Price: \$179.

Circle 50 on Reader Service Card

A-V PROGRAMMER

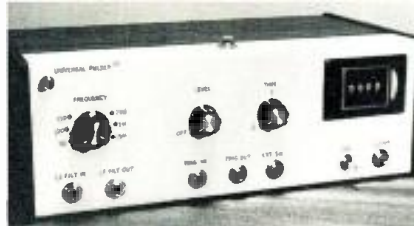

• Versatile Universal Pulser™ programmer can be used as a low-distortion sine-wave generator, a/v programmer, pulse control circuit, pulse counter, or low frequency filter. Compatible with all single-pulse film/slide show formats, it has an internal trigger circuit which automatically transposes pulse frequencies from one tape machine to another if the original pulses are recorded on a separate track; the control circuit can also be used to trigger a pulsed tape recording to other equipment. Fully-adjustable pulse length is 0.2 to 2.0 seconds. A filter suppresses low frequencies in music or voice tracks. The unit includes an automatic four-digit pulse counter which accumulates either internally or externally-generated pulses.

Mfr: Tapeheads

Price: \$399.95.

Circle 51 on Reader Service Card

STEREO CONSOLE



• Ten-mixer stereo console model 3410 has remote turn on, to be activated by an audio source. The unit mixes 22 sources with noiseless d.c.-controlled switching. A multiple bridging input allows several cartridge playbacks to connect to a single mixer without interaction.

Mfr: Sparta (Cetec)

Price: \$3,900.

Circle 53 on Reader Service Card

TIE CLASP MICROPHONE



• Elecret condenser microphone model MC-325, comes with a tie clasp, battery, 13-foot attached cable and transformer and professional style Cannon 3-pin connector for use with most standard low or medium impedance amplifiers. The unit is moisture- and temperature-resistant, qualifying it for outdoor use.

Mfr: Sescom

Price: \$45.00.

Circle 54 on Reader Service Card

AUDIO GENERATOR



• Square waves test transient response and trigger pulse generators in LAG-125 audio generator. The unit produces sine wave output and burst type signals with claimed less than 2 per cent leakage. Pushbutton switching controls frequency ranges in five steps; a 0 to 50 dB calibrated attenuator is included. Frequency synchronization is approximately ± 0.5 per cent/Vrms obtained from an external source. Frequency range is 10 Hz to 1 MHz with flat output response. Sine wave output is 0.03 per cent at 500 Hz to 20 kHz. The unit comes with a tilt-up stand.

Mfr: Leader Instruments Corp.

Price: \$499.95

Circle 52 on Reader Service Card

ECONOMY OPEN REEL RECORDER

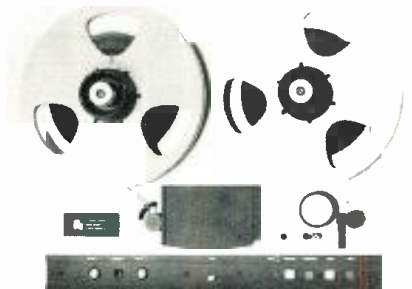

• No-frill model 750 series open reel equipment is intended for heavy use, particularly in broadcast program automation applications. It features accessible plug-in electronics and straight-line tape loading.

Mfr: International Tapetronics Co.

Circle 55 on Reader Service Card

Erase faster



Erase cleaner



Erase easier



Garner Model 70 cuts man-hours spent erasing audio and video tapes. Simple, safe continuous belt operation gives you "hands-off" professional erasures in only four seconds. Handles up to 7" reels, cartridges, and cassettes. Acclaimed by major users, yet priced low enough for the smallest studio or station to afford.



GARNER INDUSTRIES

4200 N. 48th St.
Lincoln, NE 68504
402-464-5911

Circle 28 on Reader Service Card

CURRENT DUMPING AMPLIFIER



● Model 405 amplifier, designed to drive low efficiency loudspeakers, utilizes a *current dumping* output. The current dumping system consists of a heavy duty high power amplifier, providing most of the current drawn by the load and a very high quality low power amplifier which provides control. Any error in the high power section is exactly compensated by an error signal from the low power section; performance is dependent upon the low power amplifier. Biasing is unnecessary. The output devices need not be matched. Model 405 has an output of 100 watts per channel into 8 ohms with a claimed total distortion of less than 0.01 per cent at mid frequencies. Since there are no internal adjustments, in the event of a component failure, replacement can be effected and performance restored with realignment.

Mfr: Quad (The Acoustical Mfg. Co. Ltd.)

Price: \$410.

Circle 56 on Reader Service Card

FOUR-CHANNEL RECORDER



● An automatic multi-sync feature which simplifies the process of overdubbing is notable on model 1140 four-channel tape recorder. Other features include a program memory, which rewinds a tape to a selected point and either stops or replays the material; built-in bias with 200 kHz bias frequency; logic-controlled touch-buttons for transport functions; motion sensing circuitry for anti-spill handling; peak level indicators; improved erase head capable of handling new types of tapes.

Mfr: Dokorder.

Price: \$1,199.95.

Circle 57 on Reader Service Card

COMPACT AUDIO CENTER



● Foldable D Compact audio center packs away in its own case, can be stored in a station wagon. You have a choice of one of the manufacturer's 64-series consoles, plus two turntables and a professional microphone in the complex. All audio terminations are XLR-type connectors. Inputs are accepted from three auxiliary units. The case is covered with Formica, with a vinyl bumper all around.

Mfr: Micro-Trak Corp.

Circle 58 on Reader Service Card

OSHA MEASUREMENT SET



● A Type II sound level meter, plug-in impact noise analyzer, acoustical calibrator, and carrying case are included in this OSHA measurement set. The meter has a range of 40 to 140 dB and slow and fast response A, B, C and external scales. The impact noise analyzer features peak hold, rms hold and impulse modes for measuring impact noise according to OSHA and determining loudness levels according to CHABA hearing risk damage criteria. The impact noise analyzer meets the IEC 179 paragraph 4.3 and 4.4 (supplement) for impact precision measurements.

Mfr: Advanced Acoustical Research Corp.

Price: \$765.

Circle 59 on Reader Service Card



FEATURING THE BODE FREQUENCY SHIFTERS DESCRIBED IN MARCH ISSUE OF db, AND POLYFUSION SYNTHESIZER MODULES AND EQUIPMENT

FOR DETAILS, INCLUDING PRICES AND DELIVERY CONTACT

BODE SOUND CO.
1344 ABINGTON PL.
NO. TONAWANDA, N. Y. 14120
716 - 692-1670

Circle 33 on Reader Service Card

CBS Technical Series

PROFESSIONAL TEST RECORDS

STR 100 Stereophonic Frequency Test Record

STR 101 Seven Steps to Better Listening

STR 112 Square Wave, Tracking and Intermodulation Test Record

STR 120 Wide Range Pickup Response Test Record

STR 130 RIAA Frequency Response Test Record

STR 140 RIAA Pink Noise Acoustical Test Record

STR 151 Broadcast Test Record

STR 170 318 Microsecond Frequency Response Test Record

SQT 1100 Quadraphonic Test Record

To order, please write to:

COLUMBIA SPECIAL PRODUCTS

51 West 52nd Street

New York, N.Y. 10019

Circle 34 on Reader Service Card

Dub faster



Dub easier

Garner Model 1056 updates your dubbing operation. Five 1200' professional copies in four minutes. Threads fast. Rewinds in 60 seconds. Single capstan drive and solid state electronics guarantee unvarying high quality. Priced low enough for quick payout. Write for brochure and names of users.



GARNER INDUSTRIES

4200 North 48th St.

Lincoln, NE 68504

Phone 402-464-5911

Circle 35 on Reader Service Card

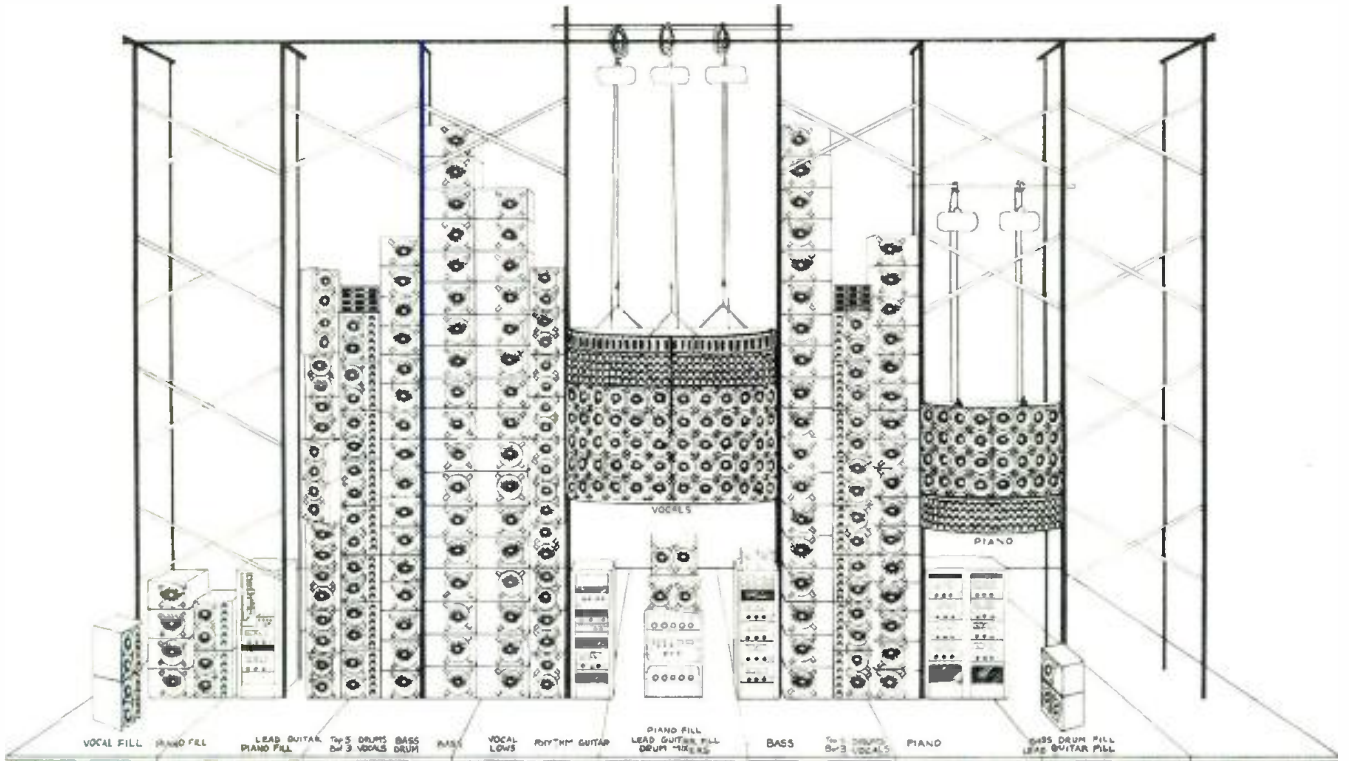

Figure 1. The Grateful Dead equipment setup, Hollywood Bowl, July, 1974.

Part I: DON DAVIS

Part II: RON WICKERSHAM

Enhancement, An Artistic Tool

The rock musician, playing in a large hall, must be in touch with total sound. Two complex arrays show how this is done, sharpening the sound as well.

PART I

THE SUCCESSFUL contemporary rock artist needs to hear and feel accurately what is going out to his audience. Neither amplification nor reinforcement suitably answer the artist's needs. Experiments with a mammoth sound system have revealed a number of significant parameters that need to be artistically considered as we approach the use of synthesizer-computer instruments conducted by artist-composers.

Don Davis heads Synergetic Audio Concepts, of Tustin, California and Ron Wickersham is with Alembic, Inc., Sebastopol, California.

A number of years ago, William B. Snow wrote me a letter, expressing his interest in a new method of equalization that I had invented. In the subsequent correspondence that developed, we found that we both shared a deep interest in the potential enhancement of a live orchestra.

Mr. Snow, in accepting the Audio Engineering Society Potts Award in 1967, remarked that he had been personally disappointed that the public had remembered the stereophonic aspect of the Bell Laboratories' 1931 demonstration with the Philadelphia Orchestra, but had failed to realize the significance of the amplified enhancement of the orchestra during the live performance of the *Fire-bird Suite*. Mr. Snow said that the resulting sound was one that would live forever in his memory.

He was encouraged by the use of enhanced sound by the rock groups which were just getting started at that time and he felt that they might point the way for the entire musical industry.

It is my belief that this is essentially true and that as the engineering community *properly* interprets what the artistic community has been seeking, very worthwhile benefits for both will be realized.

DESIGN A "ROCK" SOUND SYSTEM

One factor that is fundamental to the successful design of a Rock sound system is the ability of that system to deliver sound *to the performer's location* with a frequency and dynamic range stimulating to the performer and precisely informative so that he can judge his performance and make "real time" corrections. In the past, extensive use of stage monitors has been employed by knowledgeable sound engineers who learned to accept the fact that coverage of the performer had precedence over coverage of the audience. This is not an unreasonable requirement when it is realized that the audience attends the concert to witness an artistic experience.

Perfect acoustic coverage of the audience, if the performance is poor, is unsatisfactory to the audience, whereas quite uneven acoustic coverage will be tolerated at a concert where the performers have really turned on and done their thing, stimulated by a much sought after, seldom found, combination of the right music, a receptive audience, and a *sound* that bathes them physically as well as aurally.

This led during the early seventies to a duality of sound systems. One was the house system and the other was the monitor system. The groups, attempting to use the same equipment for both requirements, usually ended up with a split array on each side of the stage, relying on the side lobes of the main array to help the performer hear and feel the bass while using floor monitors to fill in the rest.

The desire to *feel* as well as to hear led to quite high midrange sound levels in order to bring the bass up to the desired level. Loudspeakers with high *Q* gave higher output on-axis but did not sound musical to the performer. Equalization applied to the house system often ensured that the sound system drew all the power at the low frequency end of the spectrum and often overdrove the conventional woofers adapted to this service.

AN ENGINEERING APPROACH TO MUSICAL PROBLEMS

The Rock system audio engineer has to, first, have the artistic desire, and, secondly, possess the creative ability to translate such desires into realizable hardware. The *Grateful Dead*, a San Francisco group, has approached this seemingly contradictory set of artistic desires *versus* acoustic limitations and found the following innovative answers:

1. Recognizing that the task of the sound system is no

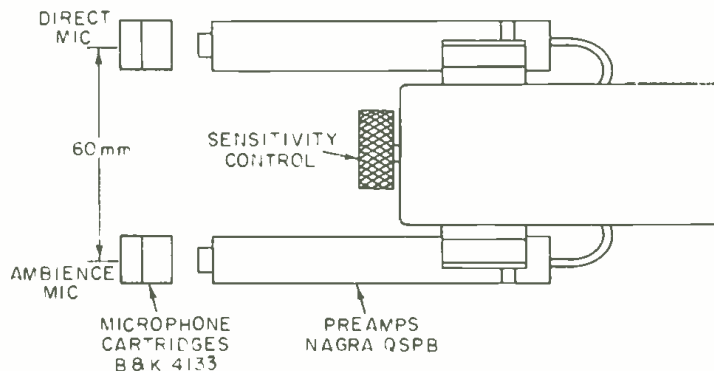

Figure 2. The differential condenser microphone design.

longer simply to amplify the artist but to become an extension of the artist's instrument, be it wind, string, vocal, etc., direct pickup of the instruments was worked out.

Instrumentation-type microphones in a differential connection were used for the vocals, thus connecting the artists directly to the electronics of the proposed system. To vary gain, the microphone's d.c. polarizing voltage was varied, changing the microphone's sensitivity.

Special electric basses were built and guitars were built or modified to be non-acoustical in nature. All acoustic output from the instruments was suppressed, making them less subject to feedback as well. Direct pickup of string motion by magnetic pickups was employed. For the piano, a capacitive pickup with polarized plates above the strings was used.

2. Having effectively eliminated feedback by reducing the distance between the performer and the microphone, D_m , to the irreducible minimum, they were then able to consider the ideal loudspeaker system. Such a system would:

- A. Bathe the performer in a physical and aural environment that he could control emotionally and physically with his musical instrument. (When there is a mixer in the audience, the performer loses control of his expression.)

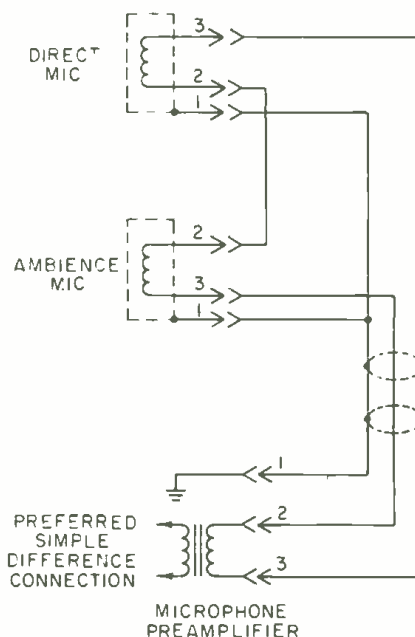

Figure 3. The preferred simple difference connection for microphones is shown at (A). At (B) don't do this!

TABLE 1

System	Number of Channels	Number of Amplifiers	Number of Speakers	15"	12"	5"	Tweeters
Vocals	1	19	226	16	60	120	30
Lead Guitar	1	1	20		20		
Rhythm Guitar	1	1	20		20		
Piano	1	8	128	16	32	80	
Bass	4	4	36	36			
Drums	3	10	120		20	60	24
Vocal fill	—	2	64		16	48	
Instrument fill	—	3	27	5	10	12	
Total	11	48	641	89	178	320	54

Note: the amplifiers used were all identical dual channel 300 watts per channel solid state type with matching transformers except for one each in the vocal and drum system which were Tube type at 350 watts, and operated the tweeters.

- B. Allow each performer to maximize his acoustic needs in terms of his individual performance as well as insure that he is a coordinated part of the ensemble as a whole.
- C. Allow the audience to hear the sound system, not so much as a reinforcement system but as a musical instrument in its own right. True stereo geometry can be achieved visually and aurally for the audience as the sound source and performers unify sight and sound.
- D. Provide the necessary hardware to support tomorrow's creative experimentation with computer controlled synthesizers.
- E. Intermodulation between instruments is eliminated by separate systems.

The result is shown in FIGURE 1. Each performer has parts of the array dedicated to his requirements but with all the parts useful and coordinated in much the same way as a classic pipe organ is utilized. Note the reverse application of directivity techniques. Because there is a musical use, high Q for high frequencies are assisted materially by the use of line radiators.

All parts of the array are separately amplified, with equalization applied, not for acoustic gain, but for tonal requirements. Obviously this is a gigantic monitor system. It consists of 480 speakers integrated into its own 40,000 pound stage and sound tower. The stage, which measures 56 feet wide by 42 feet deep and is erected 7 feet above the floor level, backed by its sound wall 38 feet in the air, can be assembled for a performance in fifteen hours.

This \$350,000 sound system not only completely solves the stage monitor problem but it gives substantially better sound at reasonable levels in the audience area. 110 dBA is a typical audience area level and it feels far more powerful than the midrange screamers putting out 120 to 125 dBA under the same conditions. The bass is very low distortion and quite powerful. Auditorium managers are impressed with the fact that it can "free up" as many as 400 paying seats in the typical arena as compared with more conventional systems. Such systems require approximately 10,000 watts of audio power.

ENGINEERING PROBLEMS

Some of the engineering problems to be considered are:

1. Determining the acoustic power each performer individually requires, what directivity factor is best at which frequencies, and what role the array design should play in tonal balance versus the ability to equalize.
2. What problems will develop when the ensemble is used in a typical environment (excessively live, reflective and noisy)?
3. The physical housing, transportation and maintenance of so much equipment. What standardizations can

be achieved and redundancies eliminated to assist in the logistical task?

In speech, we have the articulation loss of consonants, AL_{CONS} , as a guide to our design parameters. In music, what are the limiting parameters? Is the concept of *fidelity* perhaps a beginning point for further theorizing on this subject? This large array is faithful to the musical concept of a pipe organ, and pipe organs do perform well in massive environments, especially when the music allows and artists adapt their performances to the massive environment.

SUMMARY

This example of sound system design is presented without a computed tape, not because such techniques are not applicable to the parts of the sound system but because the philosophical approach must come first in all departures from what is considered conventional. Then the application of the conventional techniques can be fruitfully applied to the individual portions of the overall system.

PART II

INTRODUCTION

The *Grateful Dead* sound system is really eleven independent systems or channels as listed in TABLE 1. The sources of sound are located behind and above the performers, so they hear what the audience hears. Only one source location for each channel is used to cover the entire hall and the music is clearer both on stage and in the audience. The stereo effect is very satisfying and natural to persons all over the hall. Intermodulation distortion between instruments is non-existent.

PROBLEMS AND SOLUTIONS

A conventional rock p.a. has speaker towers to the left and right of the stage. Most listeners in the audience can hear both towers, as well as the original sound from the guitar amplifiers. But these sounds arrive at slightly different times due to the path differences from the listener to each source. If these times are varying, you get a swishing sound, the familiar *flanging effect* heard often in rock recordings. When a sound system is used outdoors, the path lengths vary due to changing atmospheric conditions and the flanging effect is clearly audible. Indoors, the path lengths are more or less fixed for a stationary listener, but he still hears a severely filtered sound, the comb notches being tens of decibels deep. Indoors or out, the effect is detrimental. In the *Dead* system, however, the single source for each instrument gives a very pleasant *acoustic*, or natural sounding music.

For rock vocals, we usually have too long a reverberation time in the rooms in which we are asked to perform. A conventional sound system actually increases the rever-

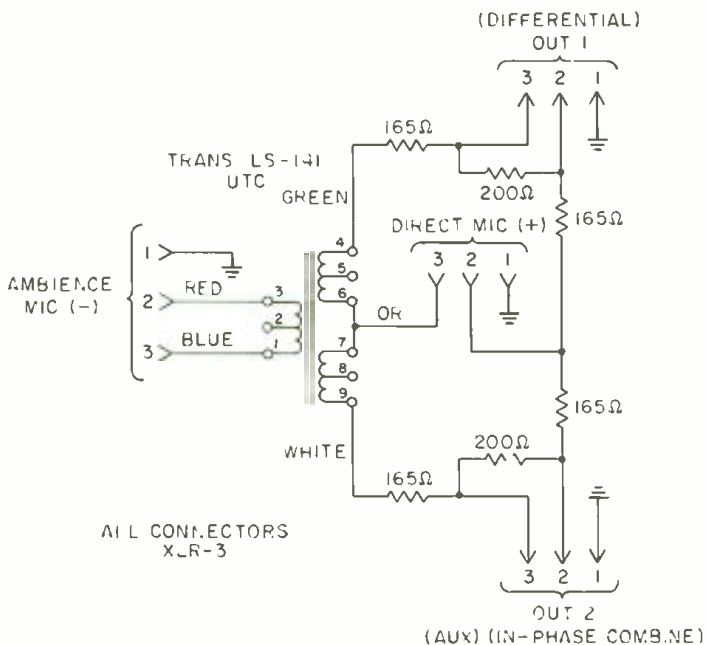

Figure 4. The preferred method of obtaining a differential microphone, as used by the Grateful Dead.

beration time of the room because the many open microphones result in the system being operated just under feedback. The microphones pick up the reverberant sound and re-amplify it, often causing the doubling or tripling of reverberation times at some frequencies. We designed microphones which do not pick up this energy and therefore the sound system does not increase the reverberation time. Careful tailoring of the array actually allows us to decrease the reverberation time, in many cases, for the vocals.

EXCESSIVE ECHOS

Excessive echoes impair the sound quality during performances in sports arenas. The sound in these buildings is worse than a simple observation of reverberation times might indicate, due to large flat wall surfaces which create echoes. In a conventional system with its multiple sources of sound, a listener in the audience hears a separate echo for each source of, for example, the lead guitar. This multiple echo effect is repeated for each instrument and causes a confusing, jumbled sound in the hall, which, in turn, leads the musicians and sound system operators to turn up the level in an effort to overcome this muddle of sound by the limiting ability of the ear. The *Grateful Dead* system, with a single source for each instrument, projects clear sound farther back into these cavernous acoustic nightmares; since the sound from each instrument comes from a different direction, the echoes are more diffuse and therefore less objectionable.

Conventional systems are set up low to the ground and the major energy is directed straight back, where it strikes the rear wall and is reflected back to the musicians with a delay approaching a half-second. Extremely high stage monitor levels are required to override this echo and musicians often complain that they can't hear well but that the high level hurts their ears. This low angle of aim also adds additional reflections from side walls, which detract from clarity in the audience area.

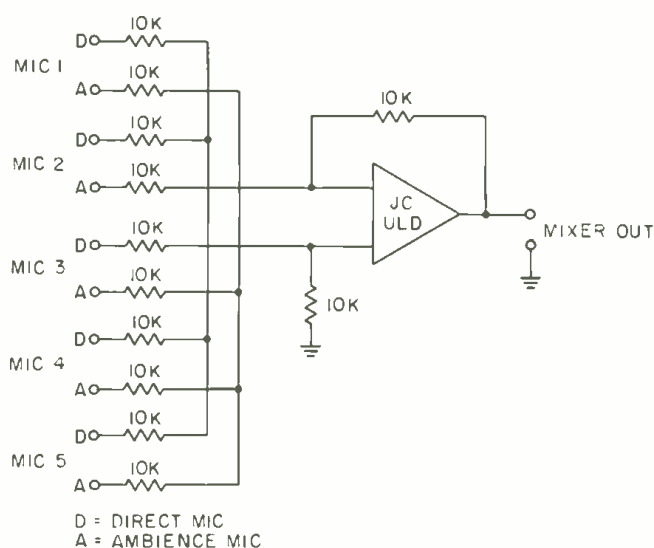

Figure 5. The condenser microphone mixer.

In the *Dead* sound system, the source of sound is higher and aimed down. The original sound is partly absorbed by the audience and the first reflection from the rear wall is reflected down into the audience for further absorption. In this way, the apparent reverberation is substantially reduced; this effect is really significant when the only absorptive material in a reinforced concrete enclosure is the audience!

In the conventional rock system, the monitors may operate only three to six dB lower in radiated energy than the house system. Because these monitors may not be aimed at any absorptive surface, this will cause a substantial increase in the apparent reverberation of a hall. Conventional systems sometimes sound satisfactory in these halls when reproducing recorded music at intermission with the stage monitors turned off, but sound confused and jumbled during the live portions of the program. The *Dead* system has no comparable monitoring energy and avoids this increase in apparent reverberation.

EXPERIMENTAL ADJUSTMENTS

To assure good articulation and naturalness, the vocal system is designed along the lines of established good practice for sound reinforcement systems as far as directivity is concerned. But for the instrument systems, deviations are desirable in certain cases for musical reasons. Many acoustic instruments are not designed to give good coverage to every seat in the house but an orchestra sounds good in a symphony hall. In the *Dead* system, the array for each instrument is experimentally adjusted to achieve the musical effect the performer desires. We found the piano system to need conventional standard coverage, and its array resembles the vocal system. For lead guitar, a more reverberant sound is desired, and open-backed cabinets are used with energy directed around the hall, and artificial reverberation is added. For rhythm guitar, artificial reverberation is added to forward-directed cabinets and in certain compositions digital time delay is added to change the sound. In the mid-bass region, because the halls are generally muddy, we have used a more directional array than is usual for the bass guitar and have achieved a very clear, distinct bass sound. Parts of the system are also employed with electronic music synthesizers in conjunction with the bass guitar and a digital computer—"an organic artificial musical intelligence."

A versatile modular packaging approach allows the

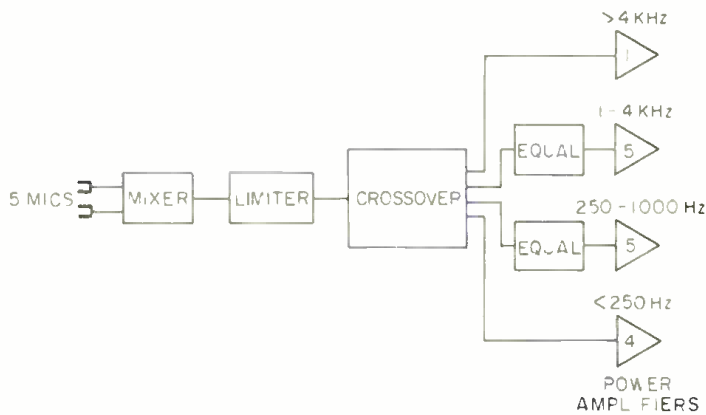

Figure 6. The block diagram of the vocal assembly used by the Grateful Dead at the Hollywood Bowl, July, 1974.

required changes which adapt the system to each individual environment. A picture of the system configured for a theatre with balcony, the Boston Music Hall, is shown to illustrate this versatility. But to give better details of how the system is configured for difficult sports arenas such as the Cow Palace, San Francisco, the detailed descriptions to follow are limited to the central vocal array configuration.

VOCAL MICROPHONES

We had used various commercial microphones and found omnidirectional and continuously variable-D types to have satisfactory sound characteristics (naturalness) for the vocals. But since it was our desire to exclude the instrumental leakage from the vocal system, we had a problem which could not be solved by a directional microphone because the instrument loudspeakers are located behind the vocalists on access with the desired pickup. Therefore, we turned to the dipole¹ type in which the response is a function of the difference of the sound pressures at two distinct points. This configuration today is usually called a *differential microphone*. As a close-talking microphone, the output is independent of frequency. This is a first-order gradient microphone and it possesses excellent anti-noise characteristics. We placed the pressure microphones about 60 mm apart (see FIGURE 2). Wider separations reduce the effectiveness for higher frequencies and closer spacings can roll off the lows since the low frequencies of the vocalist can be heard by both microphones.



A detail of the vocal assembly of the Grateful Dead's Hollywood Bowl concert, July, 1974 (Mary Ann Mayer)

Our first implementation was with two dynamic microphones connected in series opposition (see FIGURE 3). With the input impedance of the pre-amplifier much higher than the generator impedance of the microphones, each can generate its voltage properly and excellent results are obtained. We do not recommend the reverse-polarity parallel connection, as the inductance of the second microphone will attenuate the low frequencies of the vocal microphone in the same manner as a "voice" response inductor which is switchable in many microphones to roll off the bass response.

Often splitter connections must be made to the microphones for recording and live broadcasting and under these conditions the simple series system falls down. To overcome this problem, we designed the hybrid connection in FIGURE 4 which offers a relative independence of loading effects. By this time we had achieved pretty good rejection of our instrument sound field, but we felt that with closer matched microphones we could do even better.

We tried condenser measuring microphones from various manufacturers but found only one which would give us better matching than the dynamic microphones. For the final system, we chose the one-half inch free field element and asked the manufacturer to select for amplitude and phase. We obtained cartridges with amplitude match better than ± 0.1 dB and phase match better than one degree at 10 kHz! This precise match made our noise-cancelling performance outstanding—the sound quality of this microphone for music is unexcelled. We used preamplifiers designed to use the measuring microphone cartridges with a portable instrumentation tape recorder, but modified them for greater dynamic range.

SENSITIVITY CONTROL

All the direct (vocal) microphones were resistively summed and all the ambience (noise cancelling) microphones were resistively summed and then the difference was taken by an ultra low distortion amplifier (see FIGURE 5). No conventional gain controls were used; thus the signal path was kept as clean as possible. The sensitivity of the microphones was controlled by varying the polarizing voltage applied to the condenser element. The same voltage was applied to both microphones of the pair, preserving the noise-cancelling capability.

A control was mounted on a small box which served as the mounting structure for the microphone pair. This control permitted the performer to control the sensitivity of his microphone. Provisions were also made to remotely control the sensitivity when announcements are being made by persons unfamiliar with the system. Also on the remote control panel, was a switch for each microphone which would disable the ambience element, thus converting to omni-directional pattern.

For recording and broadcasting, each microphone was provided with separate difference amplifiers, each of which had two transformer-isolated outputs. Each microphone could then be recorded on a separate track.

Because of the anti-noise characteristics of the microphones, the sensitivity drops off rapidly when one moves away from the element. This causes some problems for first-time users, who must not wander around as they may be accustomed to with conventional microphones. There are those who reject the microphone for this reason. Heaters should be provided for the microphones, since condensation from the breath can load the diaphragm and destroy the match of the elements.

VOCAL ARRAY

Ideally, each vocalist should have an independent sound system; however, at the present stage we have

TABLE 2

Frequency band	Transducer size	Transducer number	Vertical length (physical)	Vertical length (wavelength)
250Hz	15"	16	26.5'	2.6 at 100Hz
250Hz-1kHz	12"	5	5'	2.5 at 500 Hz
1kHz-4kHz	5"	4	1.5'	3 at 2kHz
kHz	Horn	1		

compromised and mix five vocal microphones together into one loudspeaker array. We had decided that we did not like the characteristic sound of horn-type loudspeakers and instead worked with direct radiators as high as possible, eventually returning to horns above 4 kHz. To configure the system for a sports arena, a vertical beamwidth of 30 degrees at the half-power points is required with horizontal essentially 180 degrees. The audio is divided into four bands, each two octaves wide (see FIGURE 6). The length of each column is no more than a factor of two away from the mid-band length and thus the vertical directivity of the entire vocal array is kept uniform with simple equal-power line arrays.

The lowest band (operating below 250 Hz) is a single column of 16 fifteen-inch transducers in a line 26.5 feet long. The column is set essentially into a wall formed by other cabinets and equipment and the loudspeakers are operated within the piston band so the horizontal dispersion is essentially 180 degrees. (See TABLE 2.)

The second band 250 Hz to 1 kHz would have proper directivity with a single line of five 12-inch transducers in a line 5 feet long, but the power density would be too low. More radiators are called for but they cannot be

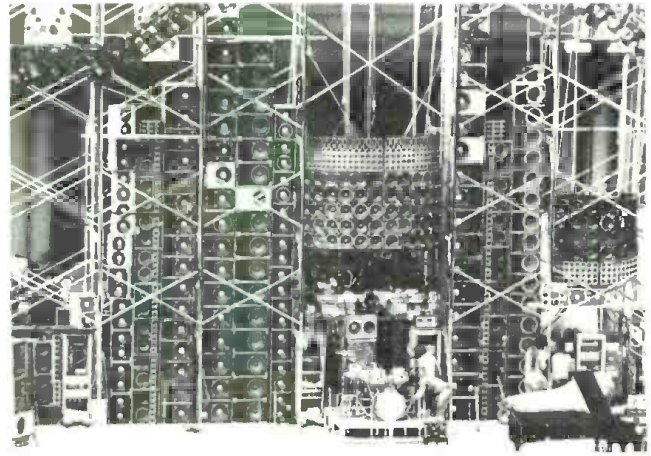

The world's largest monitor? (Richie Pechner)

added to the length without squeezing the vertical beamwidth too narrowly. Additional columns of the required 5 feet length are placed on the surface of a cylindrical arc of 120 degrees. The predicted horizontal dispersion of this array, which is approximately 8 wavelengths in radius, would be slightly less than its physical 120 degrees when measured free-field. However, when mounted with the adjacent systems forming a wall, the horizontal dispersion widened to 150 degrees at half power points. In the development of this configuration, a full 180 degree arc was constructed and resulted in unsatisfactory response smoothness, due to reflections from the wall formed by the adjacent systems. Also during development, we built curved arrays with individual rectangular cabinets which caused gaps between cabinets at the front and resulted in severe lobing. When the solid array was con-

STUDER

a standard
of
excellence.

Complete information on STUDER Professional Audio Equipment and the name of the sales/service representative in your area is available from Willi STUDER America Inc., 1819 Broadway, Nashville, Tennessee 37203. Phone 615-329-9576. Telex 55-4453. In Canada, STUDER REVOX Canada Ltd. Phone 416-423-2831. Telex 06-23310.



Circle 36 on Reader Service Card

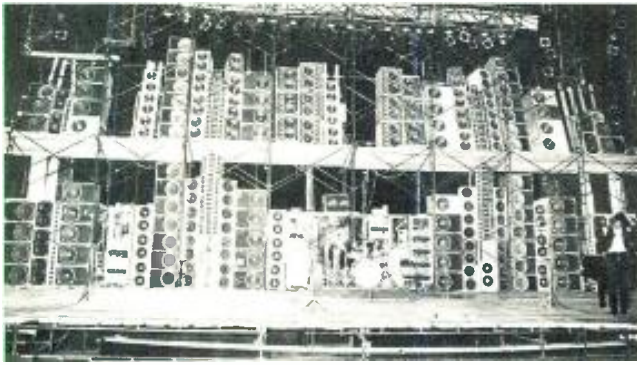

Sound system configuration for the Boston Music Hall.
(Mary Ann Mayer)

structed, the predicted freedom from lobing was happily obtained.

The band 1-4 kHz utilized a similar curved array of five-inch transducers. Above 4 kHz the same arc was continued but the elements were tweeter horns. A closeup photograph of the upper three bands shows the appearance of this array. See FIGURE 7.

High fidelity performance dictates that the fewest possible number of amplifiers be connected in series in the signal processing chain. The mixing amplifier detailed in the microphone section feeds a peak limiter, and for most songs, the limiter does not actuate. Then a crossover network with symmetrical Thompson-derived filters and 18 dB/octave ultimate slopes divide the signal into the four bands. Third-octave equalizers are inserted in the center two bands in preference to the usual technique of a single equalizer in front of the crossover. The connection

between the crossover and an equalizer is broken and full band pink noise is fed into the equalizer and the response adjusted for flat response for at least an octave beyond the crossover frequency in each direction, i.e. flat for at least four octaves. Later work with the tweeter selected indicates that an equalizer should have been used in the upper band as well.

Slightly over 10 kW are supplied by banks of power amplifiers. The amplifiers chosen incorporate output transformers which can drive loads as low as 0.5 ohm. The transducers must be connected in parallel for good performance in column-type systems. For the 5-inch transducers, 16 are wired in parallel, taking advantage of the amplifier's ability to drive low impedance loads.

GUITAR SYSTEM

All loudspeaker cabinets in the entire system are sealed boxes, except for the lead guitar system which utilizes open-backed baffles, chosen partly for the tonality required by this musician and partly for the radiation characteristics mentioned previously. Twelve-inch full range speakers high are fed by only one power amplifier of the type used throughout. Due to the nature of guitar sounds, only about 5 per cent of the power required for the vocal system is used for a guitar system, yet the guitar can sound louder than the vocals. The pre-amplifier used is a part of a Fender Twin-Reverb.

The rhythm guitar system uses 20 loudspeakers and one power amplifier also. The input equipment includes an Eventide Clockwork digital delay unit and phaser, an Orban-Parasound studio reverberation unit, and an Alembic Parametric equalizer.

The bass guitar system has two columns of fifteen-inch transducers stacked 18 high. Four power amplifiers are

FULL PROFESSIONAL PERFORMANCE AND FEATURES IN A COMPACT PACKAGE

OTARI MX-5050

What does a professional recording or broadcast engineer demand in a tape recorder? Above all, he wants consistently high performance, production and editing features, ease of operation and set up, and a reliable mechanism that won't let him down when the schedule gets tight.

If that's what you want too, then take a close look at the Otari MX-5050. It's a full capability professional machine in a compact package. This new recorder is the end result of Otari's ten years of leadership in producing Japan's finest professional recorders and high speed duplicators.

Check these features: gentle, positive tape handling; front panel edit and cue; built-in precision-aligned splicing block; front adjustable bias and equalization; synchronous reproduce for overdubbing; professional connectors, levels, and impedances; 68 dB S/N, 19 dB headroom, 60 dB cross-talk; optional variable speed dc capstan servo; motion sensing; plus many others. And if you need more than two channels, the MX-5050 is also available in four channel (1/4 inch) and eight channel (1/2 inch), the eight channel with dc capstan servo as standard.

OTARI

Otari Corporation
981 Industrial Road, San Carlos, Calif. 94070
(415) 593-1648 TWX: 910-376-4890
In Canada: Noresco Mfg., Toronto (416) 249-7316



Circle 37 on Reader Service Card

used, because the bass requires more power for equal loudness. Since the instrument has the capability to operate with individual outputs on each of the four strings, the array can be split in half on each side. When fed this way, it is possible to play chords on the bass without intermodulation distortion. Pre-amplifiers are Alembic F-2B.

THE PIANO SYSTEM

The piano system is smaller than the vocal system but configured very similarly, using a tall column of fifteen-inch transducers for the lows, and a cylindrical array of twelve- and five-inch transducers for the balance. The pickup system is achieved by means of condenser elements suspended above the strings of the grand piano, which function similarly to the condenser microphones. This pickup was developed by Dan Healy, the recording engineer of the *Dead* and built by Carl Countryman Associates.

A noise problem (hiss) was first attacked with keyed amplifiers installed after the crossover network, but we found that the playing of a soft note would open the hiss for an entire band and that this hiss was sometimes subjectively louder than the note. The problem was solved with the use of a dynamic noise filter by Burwen which functions superbly in this application.

DRUM SYSTEM

The bass drum is projected by a single column of 16 fifteen-inch transducers. A separate microphone feeds the bass drum system. Other microphones with a stereo mixer feed two drum systems for a stereo field. Each system is three-way, with 12-inch, 5-inch, and tweeters in the array. This system was basically built with leftovers from other parts of the system (the drums had previously been

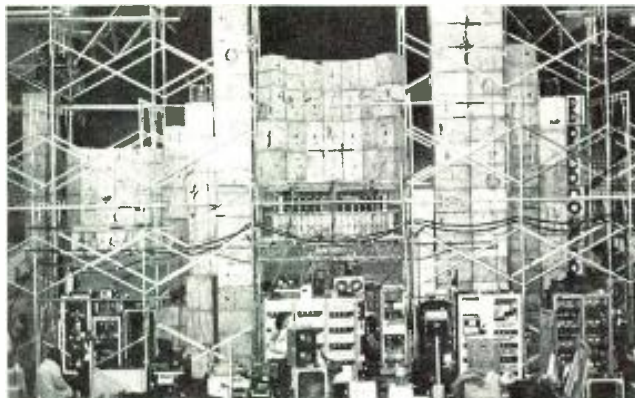

A back view of the array at the Boston Music Hall. (Mary Ann Mayer)

mixed into the vocal system) and more work on arrays, division of channels and pickups and/or microphones is in order for the drum system.

SUMMARY

This system has been under development for eight years and represents the efforts of many people. I would particularly like to recognize Owsley Stanley, whose intuition we have followed and who is the essential catalyst for the system's development. John Curl contributed elegant electronic designs and made transducer measurements. And also Rick Turner of Alembic, and Dan Healy and the *Grateful Dead* road crew who worked so hard to make the system realizable. ■

Finger our Flanger



The INSTANT FLANGER boasts a new control configuration which enables the oscillator, manual, remote, and envelope follower to be used in any combination. Its true time-delay circuit produces many more nulls than are available with a phase shifting unit (phaser), and provides a much deeper effect. To simulate true tape flanging, an effect modifier block allows the operator to imitate motor or servo hunting "bounce", and EVENTIDE'S exclusive "depth" control permits any desired percentage and phase of direct versus delayed signal, as well as true doppler shift.

Ask for a "hands on" demonstration of the EVENTIDE INSTANT FLANGER at your local professional distributor.

Let the EVENTIDE INSTANT FLANGER demonstrate its capabilities. As the latest generation of studio-quality flanging equipment, the INSTANT FLANGER maintains EVENTIDE'S world-wide reputation for providing quality equipment to sound studios and professional musicians who require the ultimate in versatility and control.

Eventide

the next step

EVENTIDE CLOCKWORKS, INC. • 265 WEST 54TH STREET • NEW YORK, N.Y. 10019 • 212-581-9290

Circle 38 on Reader Service Card

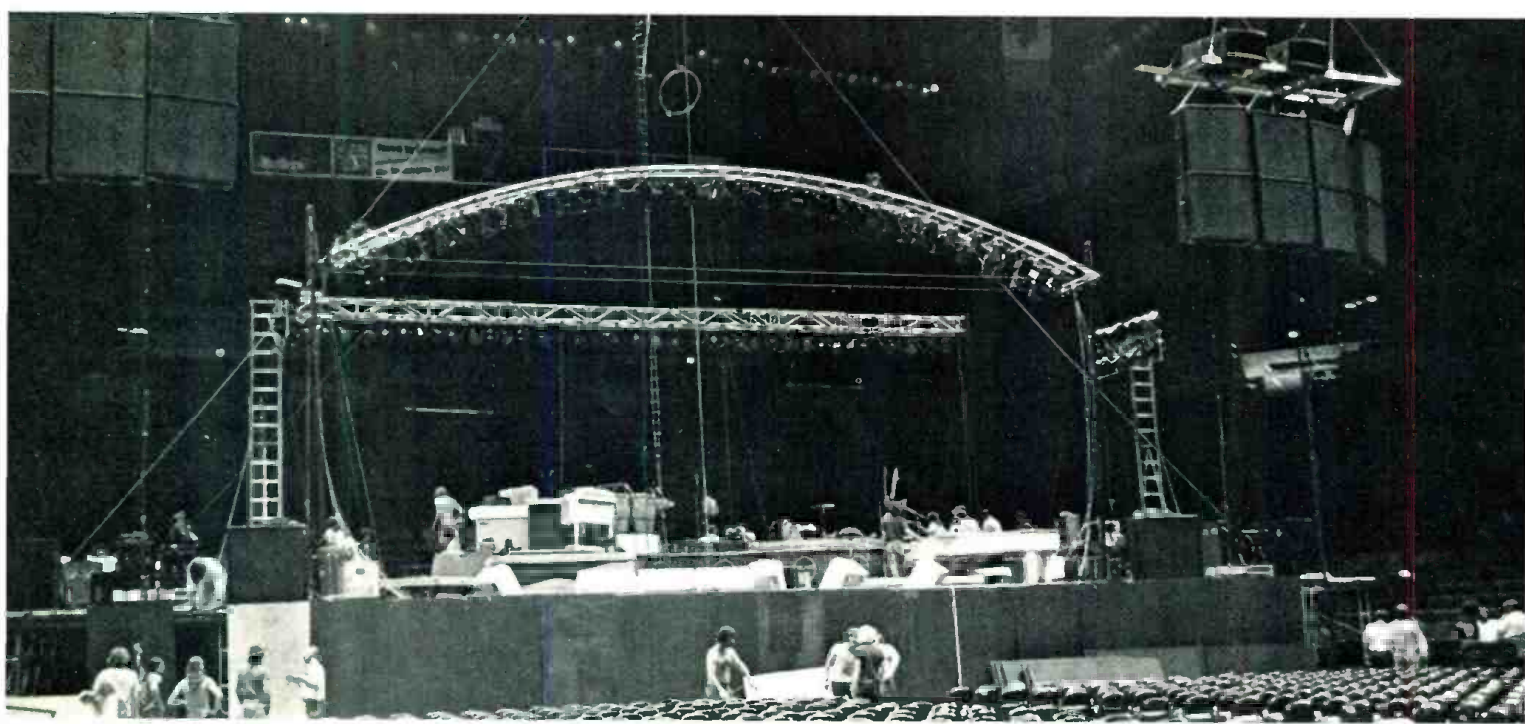

The Capital Center's stage being prepared for the first show of the Beach Boys and Chicago.

**R. A. NEILSON
BOBBY GOLDSTEIN**

Zen and the Art of Recording

Recording Chicago and the Beach Boys live requires having the right equipment in the right place—and the true harmony of professionals working in agreement.

THE PHONE RINGS at the Wally Heider Recording Studios in Hollywood. It's for Andy Bloch, remote services manager, from audio engineer Phil Ramone at A & R Studios in New York.

"I've got a remote from William Guercio," says Phil.

Andy listens. Veteran of over five hundred on-scene recordings, a remote is routine to Andy. But something from Guercio, the impresario who functions mainly from his Caribou Ranch, a plush eyrie in the Colorado Rockies, is never dull.

"Guercio wants to record a double concert, The Beach Boys and Chicago, live."

Andy is interested. Sounds like something you can get your teeth into. "When?"

"Next Monday night, at the Capital Center in Washington, D.C."

This really is impossible. A live concert, two of the biggest groups in the business with all their paraphernalia getting in the way, 2,680 miles away. Next Monday night. How do you get the equipment there in time? Can't be done.

The challenge moves up in Andy, like one of the big waves at Laguna facing a skilled surfer moving up into the lip of the thing, letting go, allowing his built-in knowhow take over. Like Nicklaus going for a 300 yard drive, willing the ball to its destination.

Andy takes a deep breath, bulldozing away the doubts, the objections, the petty temperamental things that can get in the way.

R. A. Neilson and Bobby Goldstein are from California. Mr. Neilson heads the advertising firm of R. A. Neilson Co.

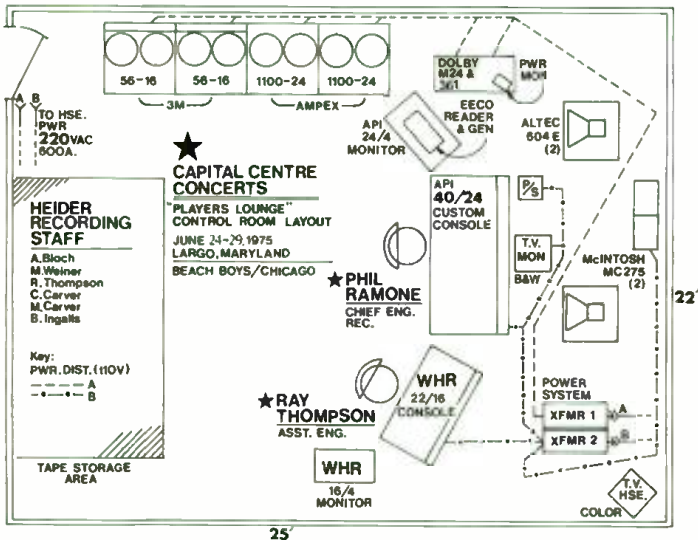

A players' lounge is transformed into a control room.

"Want to go into it with me?" asks Phil.
 "Sure," says Andy.

Phil laughs. Something, almost a fibrous connection, moves through the telephone lines. The two men are on the same wavelength, ready to plunge into the big one.

Phil begins by telling Andy the facts. It's a five-day gig, end of a season's series of concerts.

"The Beach Boys, who play first, use forty-some mics, plus directs for keyboard and bass. Ditto for Chicago. Eighty mics."

"Uh huh," says Andy, seeing a jungle of eighty mics.

"Guercio figures that for each of these sections, the guys use each other's mics. He wants the house miked. I told him that four mics in a quad-like arrangement should do."

Andy grunts agreement.

"But for the finale," Phil reminds him, getting back to the eighty mics again, "the groups appear together doing an extended encore set. Eighty mics could be a problem. What about ganging the equipment and running everything in doubles?"

Andy considers a moment. At one time he would have thought that was impossible. But he'd seen it done. "It'll work," he says briefly.

When Phil hangs up, Andy moves into the thing. One step at a time, in the moment. You just take care of what's in front of you. Clean.

He dials Caribou's Los Angeles office and they send over a messenger with stage diagrams. Andy does a gross estimate of the bulk of the equipment needed—details can come later. If they could use the truck, Heider's studio-on-wheels. . . . They can't use the truck. It's too far and there's not enough time.

Concentrate on what's present, not on what's not present. It'll be a little close, but he thinks everything should fit into two 747 air freight "A" containers.

After a few hours of mini-calculations, aided by Myles Weiner, chief engineer and technical heir to many of Wally's remote secrets, Andy gets back to Larry Fitzgerald at Caribou's L.A. office with a price. Larry okays that. He fills Andy in on the situation. Claire Bros. of Lititz, Pa. have been handling the p.a. on the tour. Joining the crew for this special show will be a Washington t.v. film crew from WMAL, shooting a 16mm documentary. Visions of a horde of technicians and cables dumped like

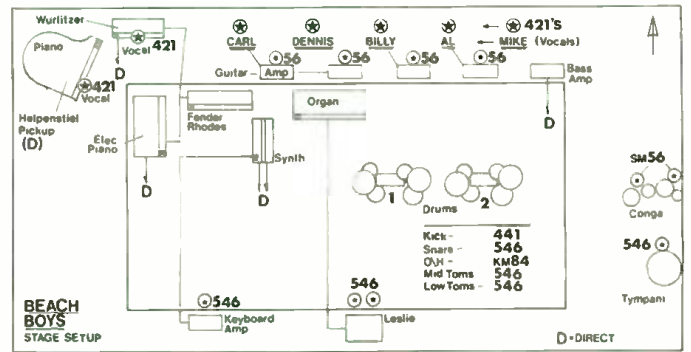

The Beach Boys stage setup.

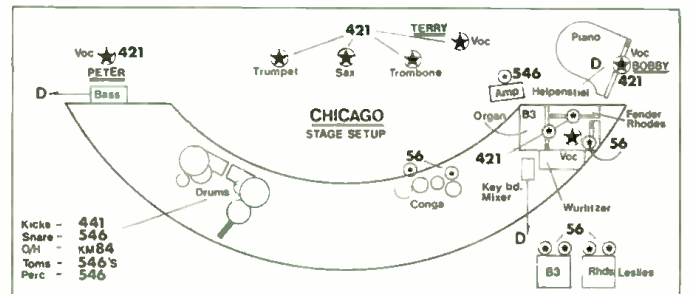

The Chicago stage setup.

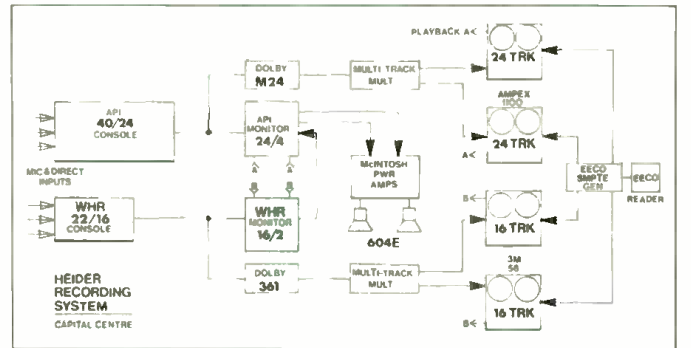

The Heider arrangement, showing monitors placed in a room that is not acoustically treated.

spaghetti all over the place flicker through Andy's mind. Not now. Come to that when you come to it.

"What kind of facilities can they offer us?"

"If the control room isn't adequate, there's the basketball players' lounge," says Larry.

Andy can just see it. A bare, white-walled room. This has to be transformed into a complete control room with a custom power system, closed-circuit t.v., an EECO/SMPTE Time Code Generator and Reader, complete monitoring facilities, chairs, tables, clip-on lights, ash trays—all the necessities and amenities for a staff of six. Additional analysis reveals that Heider will need two 24- and two 16-track tape machines, a total of eighty channels and two large consoles.

Six people are selected for the crew. Then there's Ray Thompson, Heider's top remote engineer as co-pilot to Phil, Andy Bloch as overseer-negotiator and interface between the Heider people and Ramone's staff, a phalanx of union men, managerial heavies, and security people.



Mike Carver and Brian Ingalls in the early set-up stage of the control room.



Claire Brothers P.A. Company technicians cabling their main speaker system.

MOVING IT

A timetable is mapped out on Andy's desk. American Airlines is called to find out how close they land to the Capital Center, located at Largo, near Washington, for both passengers and freight. The secretarial staff books living accommodations for the week as close to the Center as possible.

Now Andy's on the phone with American Airlines, scheduling the transportation of the equipment. "Doc? I think what we'll have is around 11,500 pounds—six tons of equipment. We're thinking about two of your containers, on a 747—what's the nearest airport where it can land? Philadelphia? Okay. Then you'll load each container on an American AA truck and bring it to Baltimore? Terrific."

So far, perfect. Next step—getting the stuff from Baltimore to Washington. But Hertz tells him that the only suitably sized trucks are in Washington, D.C. So you move with it. He'll fly the crew to D.C., where they'll pick up the trucks, drive them to Baltimore, make connection with the airline trucks coming from Philadelphia, and truck the stuff back to Washington. No problem.

In Hollywood, the loading space next to the Heider studio is a shadowy, sunless area. The dimness gives the scene the quality of some mad-rock movie set. A small forest of mic stands hold their part of the floor against the continual intrusion of links of snakey-coiled mic cables being tossed at their bases. Mic cases jockey for space with the Heider custom bridging boxes. In the center of the floor, the heavy equipment huddles: a 40-input 24-track custom road board; a Wally Heider 22-input 16-track board; complete monitoring systems for the above; 16-track tape machines; Dolbys; power amps; monitor speakers; a video monitor; a custom communication system. Plus tool kits, mult boxes, and spares on everything, in case there's no supply store open in Largo at four o'clock in the morning. Clustering around the pile are the protective containers, specially designed to guard fragile equipment from things that go bump in the flight.

WASHINGTON—ALL SAFE

By the next afternoon, Andy Bloch is leaning against a pay phone wall in Washington, reporting to his boss, Ron Trowbridge in Hollywood. "Well, we picked up the trucks in D.C., loaded the stuff in Baltimore, and arrived here around two this afternoon. And it's beautiful."

Andy offers his associates near the phone booth the same gentle regard they return to him. This is part of the

operation, the lubrication, the unseen generation that keeps things moving smoothly. People . . . regard for them, knowing that whatever's happening is not just the movement of things, but keeping aware of feelings. Creating agreement. Agreement's the thing that untangles ticklish situations before they become barriers.

Like Andy says later, thinking about it. "One of the roughest things about that remote was—for me—trying to please everybody, making sure everybody was taken care of."

There were little things that could have turned into hassles, like the time when the t.v. film crew was shooting footage in the control room and using up precious power with their film lights. You had to handle that; they had their needs, you had yours. No reason to argue. A quick arrangement was worked out whereby the film makers had access, with certain conditions, at specific times, to the room.

And then there were the groups. Andy moved carefully. This was the talent; he respected that. "The groups came up to me," he recalled, "and asked me what I wanted them to change and I said 'Don't change anything' because it'd mess up their performance. I'm the one who should go in there, no matter how they're set up, and just isolate them and make good sound. A lot of people would change them around. They'd put baffles in there, make them turn an amp this way, change the set-up. Being an artist is really hard and it's the performance that counts, no matter how good the sound. If their playing's been affected because you've confused them, you've got nothing."

KEEP EVERYONE COMFORTABLE

Not to forget the p.a. people. "Since the p.a. guys kept changing the number system that came back to us, I had to make hot patches between the two groups right behind the board. The numbers kept changing. Between each act, I'd re-bus the board. You got ten, fifteen minutes to reevaluate all of that. plus something might go wrong on stage between acts—can't get a mic working, for instance—so I have to run out there too, make sure that's going; then I come back and finish my patching. If you set everything up so everybody's comfortable, they never get upset. That's why I never change their numbering system. Even if I may not agree with it, I use their language and worry about it on my end. We do it this way so they don't get messed up. They've been doing the show for weeks and we don't want to mess them up. It's a dumb thing to change a guy around."

So as Andy looks at his crew from the phone booth, something else besides professionalism passes between them. Trust. Respect. Agreement.

SETTING UP

"The place looks big, but not too big, maybe 20,000 seats total," he tells Ron. "It has this enormous closed-circuit video in-house production control room with cameramen to cover the whole shot, live editing, and four-sided large screen overhead projection."

"Where are you setting up?" asks Ron.

"Well, the existing sound control room won't work. So we're using the basketball player's lounge. Phil Ramone's here and the crew has been at it for the last four hours aligning machines. Tonight we're going to see if we can use any of their video for monitoring, but I believe it'll be more elaborate than what we need."

Andy decides to move into the job slowly at first, getting the feel of the concert. After all, that's what he has to deliver to the consumer who'll buy the record—the *alive* sharing of Chicago and the Beach Boys in Concert. The concert will run for five nights, so there's no rush. The first night, they go to the concert, like the paying customers, enjoying, but with their antennae out to pick up the ambience of the thing.

Now it's time to move into the big wave. The job picks up momentum. Running—that's what it amounts to for Andy Bloch—running between engineers Ray Thompson of Heider and Phil Ramone, to the crew, to the source of whatever problem that was cropping up at the moment. Or, as Andy puts it, "Eliminate, in a nice way—any and all items that can create problems or that the crew thinks can create problems."

Like the light and sound lines, with the constant danger of mutual affectance where, when the lights go down, the sound buzzes up. Attention has to be paid to the proximity of these lines to each other. The Heider people work it out with the Claire Bros. p.a. crew. In the quality of the recorded sound, there is also a dependency on the Claire Bros. expertise. If the p.a. system develops acoustical feedback, the recorded sound will reflect that.

With a p.a. company involved, it's hard to get all the directs and get them clean. Ray Thompson and Phil Ramone move into that. The Beach Boys have six or seven keyboards. The engineers cover themselves by putting a mic on each.

"If you just have a direct and don't cover it," says Ray, "that's not smart, because if the direct goes, and that's the most common thing that will, where are you? Like a Fender Rhodes, someone will crank that thing up and blow the direct. There's no way to fix that. Your miking technique is about 90 per cent of the battle.

"The other ten per cent is letting yourself get nailed—and not over-reacting. You flash on it and you just keep going. It's a lot like combat photography."

"But safer," quips Andy.

Ray says, "I've worked with guys who, when someone would pop the mic they'd say, 'We'll get that out later.' I say okay, guess the guy's got some sort of miracle dipper I've never heard of. It's like feedback; you can't get it out. Once it's there, it's there. The first rule is to get the show on tape *clean*."

Most elaborate p.a.s. carry up to 32 inputs, but Phil and Ray have 37 to mix into the stereo Altecs in the players' lounge, with 65 or more mics at their fingertips.

IT'S GOT TO BE CONSISTENT

The monitors are a big item. They have to be set up on location in a totally new room that's not acoustically treated for anything. And it's got to be consistent. There's where the planing and trucking of all that equipment pays



Andy Bloch.

off. Andy's crew has brought their own systems—well-known reliable monitors, like Mac, or Altec.

The two engineers, Ray Thompson and Phil Ramone, one from New York and the other from Hollywood, slip into a teamwork that's beautiful to see. That agreement thing of professionals. Each engineer wants to hear something special, something that his console is doing, clear and clean. Then there are the subtleties that mixing engineers are listening for when they're blending sounds.

"There were times when one engineer got his whole board kicking and the other engineer was flying blind," recalls Andy later, "soloing one input—and of course they don't warn each other when they're soloing—they're each working independently, but together. It could be very frustrating for one engineer as the other is soloing his own console, to try and catch certain tracks that don't appear on his board."

Each night after the concert, the engineers merge to critique the sound, mostly concerned with getting it *finer*, changing mics, getting better isolation. Once it's all hooked up, there's no reason for any buzzes, hums, or anything else so they can concentrate on getting a better and better sound. "Really articulate," as Ray puts it.

THE JOB PULSES WITH MOVEMENT

The job pulses with movement. The pit doesn't stay set up. It goes from one act to another and then back to both acts at the same time. The whole stage moves; it rolls around. Cables have to be checked and lengthened, mics repositioned and changed, and all without interrupting anybody.

The gig gets down to a routine. "Nobody's the hero,"



Ray Thompson relaxing with the API recording console and monitoring system in the rear.

To each his own.

Degas. Gauguin. Gauss?

It may sound presumptuous,
but the point we'd like to make is that
Gauss Precision Loudspeakers are designed
and made with the creativity, hard work and
desire for perfection
of a fine work of art. And, like
any work of art,
they're worth more and they last longer.

Gauss
Precision Products by
Cetec
audio

A DIVISION OF CETEC
CORPORATION

13035 Saticoy St. N. Hollywood, Ca. 91605 (213) 875-1900

Cetec, U.K., Sapphire House, 16 Uxbridge Road, Ealing,
London W5 2BP Phone: 01-579 9145 Telex: (851) 935847



220-volt stepdown transformers being tapped for the optimum voltage.

says Ray. "We were just working toward getting our job done in the best possible way."

The operation takes form as the days pass, finer and finer. The gears are smooth. Everyone's cool, moved out of himself into what he's offering the job. Zen? Maybe. Professional, certainly. Simple, when you open yourself to it.

There's respect for the performers. "Those guys are super good on stage," says one of the crew. More reason to achieve a recording that will do justice to that.

Each night, after the gig, they play cards. They get up the next morning, looking forward to another good night. But they've covered themselves for emergencies, just in case. "Planned redundancy," someone calls it.

By the end of the week, the hotel room almost gets to feel like home, especially once you've mastered the hours when the coffee shop is open. And just when you've gotten the taping of the concerts down to a science where you've become familiar with what the nods of the musicians' heads mean to each other and you discover where to park your truck to avoid getting stuck in the after-concert traffic jam—it's over. Boom! The big wave hits the sand and fizzles into slowly moving postscripts.

The two hundred red recording lights are "killed," and the hundred and thirty-five meter needles—having danced all week to the music—fall back, lifeless. The bluish light of the video monitor remains on, picking up the moving heads and sometimes the waving arms of departing fans.

Consoles and racks are shut down, ashtrays and cups are emptied into plastic-lined litter boxes. One of the crew goes to the piano they didn't need and haltingly plays a few chords of *Chop Sticks*.

The guys are clustered in the center of the control room the way they were on the night of their first taping. The whole week that has just elapsed starts shrinking into a memory ten minutes long. Tomorrow they'll have time to strike the load and split for the airport in Baltimore, where, like reversing a home movie, they'll repeat all the steps they took to get the tape, the equipment, and themselves to Largo—this time back to Los Angeles.

Someone materializes a magnum of local "house brand" champagne, and after the cork is worked free and aimed toward that part of the ceiling away from the equipment and popped, Ray is prodded to propose a toast.

Ray thinks for a moment, cocks his head, grins and says, "Hell. It was a mere meatball."

P.S. For those interested in such things: the four nights of Beach Boys and Chicago tapings consumed 50 reels—over 165,000 feet of two-inch tape. Or, as Guercio would say, "That's a lot of spaghetti." ■

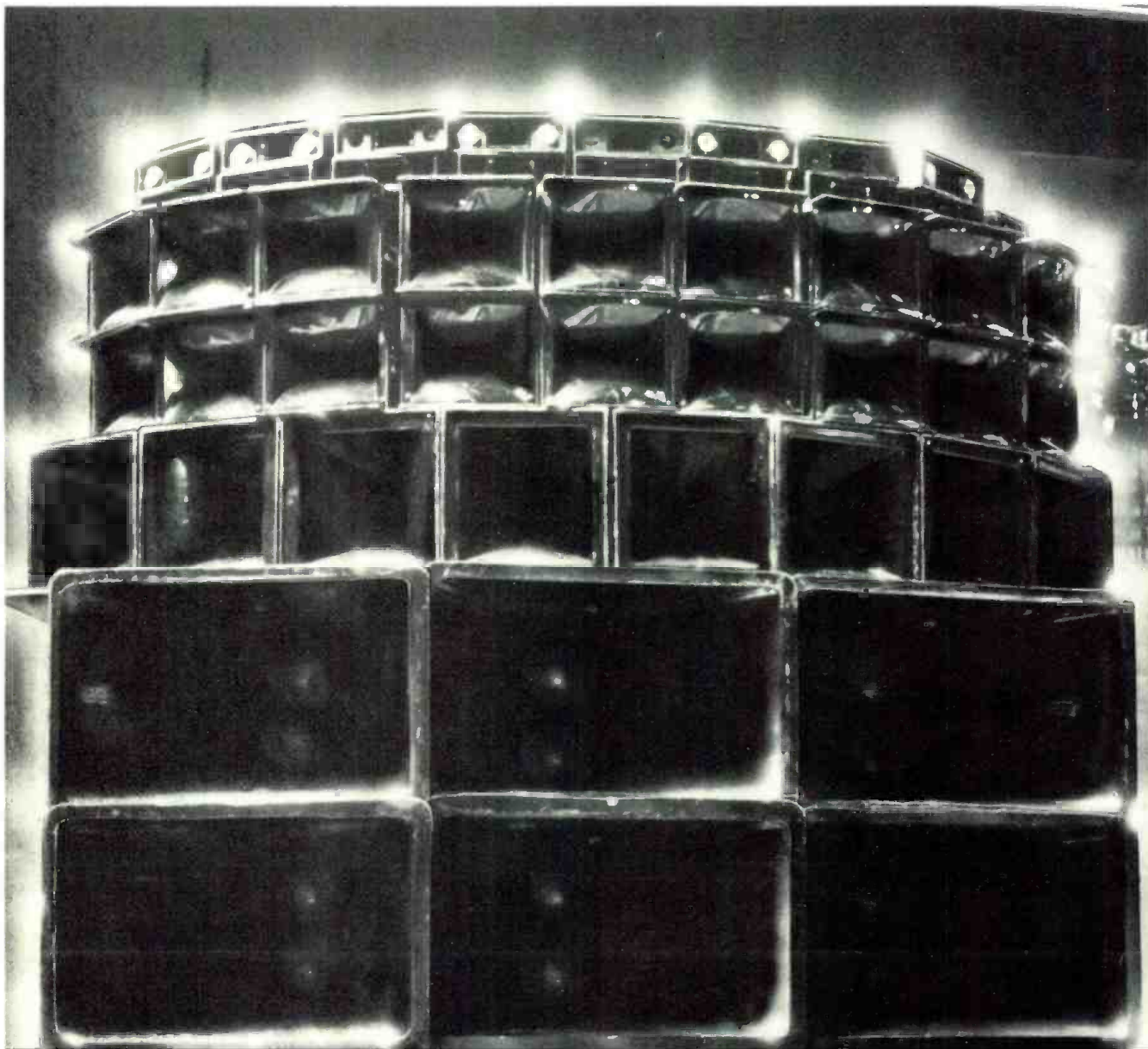

**THE STATE OF THE ART
IN SOUND PRESSURE CAPABILITY & EFFICIENCY**

Community **LIGHT & SOUND**

5701 GRAYS AVE., PHILADELPHIA, PA. 19143 (215) 727-0900

Sound Reinforcing 'The Midnight Special'

It was fast—it was loud—and there were eight different acts.

I WAS FIRST CONTACTED about the feasibility of the project on February 24, 1975 by Jacque Andre, the associate producer of "The Midnight Special." We would have less than three weeks in which to put together the whole system. This was tight; among other things you had to consider shipping schedules and the availability of special equipment. But I flew to Los Angeles, met with the "Midnight Special" and NBC technical personnel in a lengthy session. Finally we all agreed that we could do the job within the time limits. All equipment was air-shipped from Chanute, Kansas to Chicago the next day, to the Bartlett Gymnasium at the University of Chicago.

The basic requirements were, to say the least, stringent. There would be two stages, approximately 150' apart (FIGURE 1). The main sound reinforcement system would consist of two folded-W bass cabinets and two radial horns on each side of both stages. There was also a thick black drapery completely surrounding the stages on the two sides and rear. This was for the benefit of the camera more than the audio, although it did seem to break up stage reflections from the on-stage monitoring systems.

The gym is located on the second floor of the building and an oval indoor track is located approximately twelve feet above the gym floor. Needless to say, the building was very "live." Approximately 1,000 to 1,500 people were in the building for the two nights of taping, helping the reverberation problem to some extent, although in the end the echo demon was driven away by the usual electro-acoustical approach—brute force.

MONSTER POWER DISTRIBUTION

A.c. power distribution is always a problem with any large show, but with the additional load imposed by the very large number of lamps required for color television taping, a.c. distribution seemed to grow into a monster. The stage lighting alone consumed all the building's existing power capability. All audio a.c. power, which included

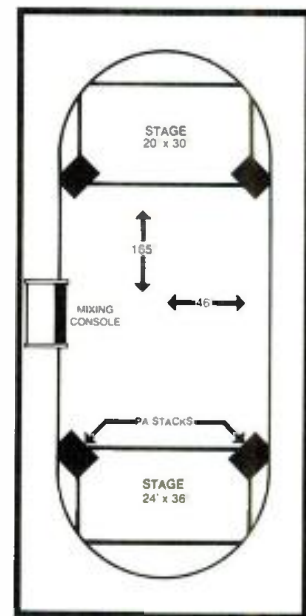

Figure 1. Staging and concert hall dimensions.

juice for the Metro Audio recording truck, sound reinforcement system, and all stage equipment, was brought in on a separate feed. This eliminated any noise due to light dimmers and the lighting control panel. Anyone seriously considering such a system should specify this type of power distribution.

The sound reinforcement system is block diagrammed in FIGURE 2. The speaker systems consisted of two folded-W type horns with a usable low end cutoff frequency of 40 Hz and two extended range driver/horn combinations on each side of each stage. The horns used had a 90 degree horizontal and 40 degree vertical dispersion characteristic; the drivers were the new Electro-Voice DH 1012 extended range/high power device which have a very high reliability factor. Reliability is of prime concern at any time, but when equipment is used in conjunction

with a remote color videotaping and 16-trac audio taping, you simply do not have time to replace blown diaphragms or speakers.

The power amplifiers were of the bi-amplified configuration and a crossover point of 500 Hz was selected. The power amps have selectable crossover frequencies of 500 Hz, 800 Hz, or 1,000 Hz. The crossover point used was determined by general consensus of opinion of what sounded best. In terms of power used, the total rms power of the entire system was only 1,700 watts. This is a relatively low power for a sound reinforcement system, but it must be remembered that the total audience was approximately 1,500 people and that color t.v. cameras tend to get microphonic when subjected to very high sound pressure levels. The power amplifiers delivered approximately 125 rms to each pair of horns. The sound pressure measured at the center of the audience using the (A) weighting scale exceeded 103 dB for most acts.

All stage miking was done by Metro Audio and NBC personnel, under the supervision of the appropriate unions. The people involved were very easy to work with and considering the very long hours, there were surprisingly few adamant differences of opinion. A typical stage setup is shown in FIGURE 3. All stage diagrams were prepared well in advance to setup time, and saved quite a bit of time in preparing a stage for each act. Microphones were provided by NBC or Metro Audio, unless a certain group had specific requirements and supplied their own. The sound system feeds were taken from splitter boxes located at the rear of each stage. A 27-pair snake was used from each stage to the sound reinforcement system mixing consoles. All high level returns to the power amplifiers for the sound system and monitor system were sent back to the stages through separate shielded, twisted pair lines.

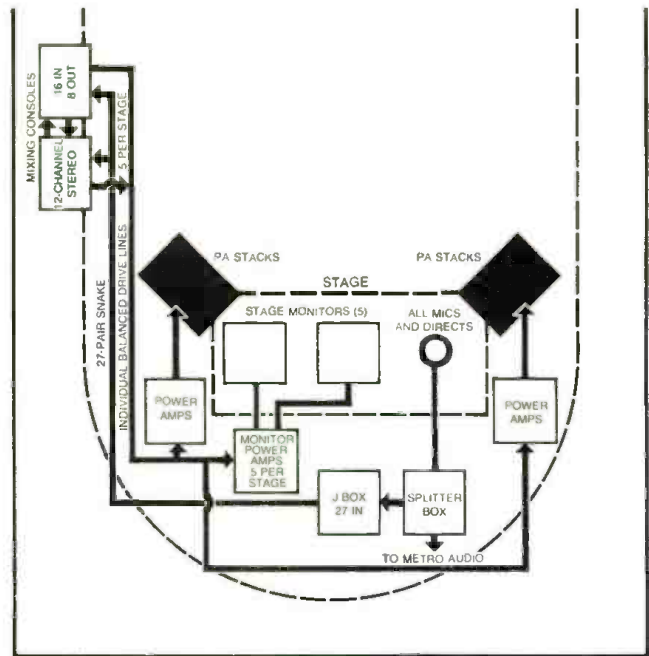

Figure 2. Sound reinforcement system.

One main system feed and five monitor sends were used for each stage.

THE ON-STAGE MONITOR PLAGUE

Of all problems relating to sound systems, the on-stage monitor is probably the worst. A total of five monitor slants were used on each stage. The speaker system or

The De-esser.

The Orban/Parasound 516EC Dynamic Sibalance Controller finds its way into more top recording and film studios every month — because it really works. Unlike compressors and limiters with afterthought “de-ess” functions, the 516EC doesn’t pump or breathe, and it’s not fooled by low-frequency energy. Unlike dynamic filters, it controls sibilance by reducing gain at all frequencies — so low-frequency intermodulation products which often accompany sibilance overloads are effectively reduced along with the sibilance itself. In addition, the threshold of the 516EC tracks the average input level, so de-essing is constant despite changes in input level of 15 dB or more.

With a 107 dB overload/noise ratio, and distortion typically below 0.1%, the 516EC is a fitting companion to state-of-the-art studio gear. And its ease of use simplifies a hassled mixer’s life: there’s only one adjustment necessary to determine the amount of action. A LED lights whenever de-essing is taking place, and the action can be defeated in the middle of a track without clicks or gain changes.

The \$595 Dynamic Sibalance Controller contains three independent channels to handle separate vocal mikes or magnetic dummies without interaction. A dual-primary power transformer puts it at home anywhere in the world while levels and impedances permit easy interfacing with any professional audio equipment.

516EC customers often wonder how they ever got along without it. And in today’s competitive studio market, the creative freedom offered by really effective de-essing yields a strong competitive edge. For further information on the 516EC Dynamic Sibalance Controller, see your local Orban/Parasound distributor, or contact:

orban/parasound

680 Beach Street
San Francisco, Ca. 94109
(415) 776-2808



Circle 41 on Reader Service Card

Get serious.

If you're really into sound, you've got to make the move from yesterday's P.A. systems to a truly professional one. And don't take a chance on "living room" equipment that won't hold up on stage or on the road.

The BOSE 1800 Professional Power Amplifier is built to take professional punishment, the kind your equipment gets, show after show. And, the BOSE 1800 delivers enough power to handle anything you can give it... and more.

We prove our confidence with a full 5-year warranty. Prove it to yourself. Get serious about your sound. Get BOSE.



Please send information on BOSE Pro Products to:

Name _____
 Address _____
 City/State/Zip _____
 Telephone (____) _____
 Return to: Dept. SE, BOSE, The Mountain, Framingham, MA 01701

Perfect Timing



console mount clocks and timers

Reliable ESE clocks and timers are now available in compact (2" x 3.7" x 3.6") console mount enclosures with bright easy to read .33" red LED's. Provided with rear solder pins for connection to your own switching or the optional remote connector, 6' cable and pushbutton set. Other options include: BCD Output; Crystal Timebase; 220V-AC-50Hz; and Kit Form. In addition the ES-370 is available with Stop and/or Relay Contact Closure at Zero.

ES-172 12 Hour Clock \$125.
 ES-174 24 Hour Clock \$125.
 ES-370 100 Min. Up/Down Timer \$180.
 ES-570 60 Minute Timer \$125.
 ES-572 12 Hour Clock/Timer \$150.
 ES-574 24 Hour Clock/Timer \$150.



Write, Wire or Call: (213) 674-3021
 505 1/2 CENTINELA AVENUE • INGLEWOOD, CALIFORNIA 90302

Circle 42 on Reader Service Card

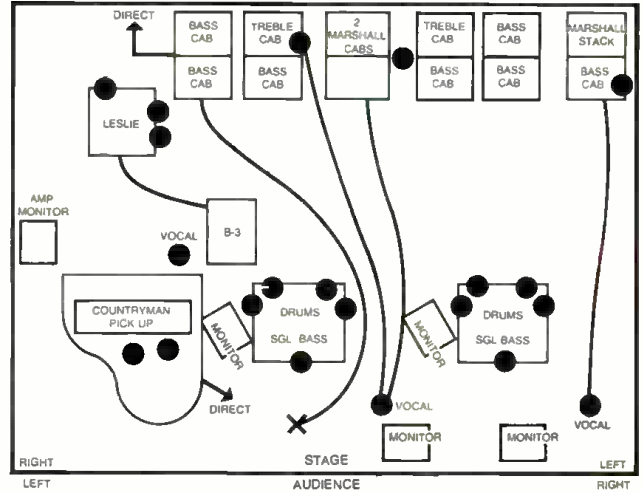

Figure 3. Typical stage setup.

slant consisted of one 12-in. Electro-Voice SRO bass speaker and one diffraction horn and driver for the mid/high frequencies. A 12 dB per octave crossover at 1,500 Hz split the power between the speaker components. The slants were physically located at the null of the microphone pattern whenever possible. This, along with wide band equalization of each power amplifier associated with a slant, allowed very high levels before feedback. In my opinion, the monitor system is the most overlooked portion of a sound system. The performer must be able to hear himself and any other persons or instruments in order to give his best performance. This requires a wide range high power speaker/power amplifier combination. The monitor power amplifiers used delivered 130 watts rms of power and had a seven band graphic equalizer as an integral part of each unit.

The actual sound system mixing was done with two twelve-input stereo consoles and one sixteen-in/eight-out console. The multiple output console was used for monitor mix only and provided the needed flexibility in sending combinations of sources back to the stage monitor power amplifiers. All instruments were fed through the twelve channel boards. A mixture of miked and direct feeds were used. Some acts had enough equipment to do a 10,000 seat concert on stage and therefore only selected instruments such as acoustic guitars, keyboards, horns and vocals were put through the sound system. The desirable "mix" for the audience was thus obtained by direct sound from the stage and additional enhancement from the sound system. Each of the 12-channel boards had nine band graphic equalizers and it was found that that was all the room equalization needed for this application.

THE CRUCIAL OSCILLOSCOPE

The shows went off with a minimum of difficulty, considering that there were eight different groups and two stages. After completion of this job I concluded that two of the most valuable assets an engineer can have are much patience and a portable oscilloscope. Having a 'scope with adaptors to plug into any part of a system is an invaluable tool for finding out what is happening at any given time. Some people prefer earphones and an amplifier, but I don't see how they can hear anything of value over the high ambient sound level. With a 'scope, however, you can see what stage of a system is clipping or gone completely, and pinpoint that strange noise. Besides that, you can usually show a musician what is happening much easier than it is to try to explain a problem that may or may not exist.

The Contributions of Edsel Murphy to the Understanding of the Behavior of Inanimate Objects

This valuable contribution to the theoretical understanding of the engineer originally appeared in EEE magazine. It is reprinted with their kind permission.

Reprinted from db April 1968

I. Introduction

IT has long been the consideration of the author that the contributions of Edsel Murphy, specifically his general and special laws delineating the behavior of inanimate objects, have not been fully appreciated. It is deemed that this is, in large part, due to the inherent simplicity of the law itself.

It is the intent of the author to show, by references drawn from the literature, that the law of Murphy has produced numerous corollaries. It is hoped that by noting these examples, the reader may obtain a greater appreciation of Edsel Murphy, his law, and its ramifications in engineering and science.

Manuscript received April 17, 1967; revised June 3, 1967, additional revision March, 1968. The work reported herein has not been supported by grants from the Central Intelligence Agency.

Consideration is given to the effects of the contributions of Edsel Murphy to the discipline of electronics engineering. His law is stated in both general and special form. Examples are presented to corroborate the author's thesis that the law is universally applicable.

As well known to those versed in the state-of-the-art, Murphy's Law states that "If anything can go wrong, it will." Or, to state it in more exact mathematical form:

$$1 + 1 \text{ ☞ } 2 \quad (1)$$

where ☞ is the mathematical symbol for hardly ever.

Some authorities have held that Murphy's Law was first expounded by H. Cohen¹ when he stated that "If anything can go wrong, it will—during the demonstration." However, Cohen has made it clear that the broader scope of Murphy's general law obviously takes precedence.

To show the all-pervasive nature of Murphy's work, the author offers a small sample of the application of the law in electronics engineering.

II. General Engineering

II.1. A patent application will be preceded by one week by a similar application made by an independent worker.

II.2. The more innocuous a design change appears, the further its influence will extend.

II.3. All warranty and guarantee clauses become void upon payment of invoice.

II.4. The necessity of making a major design change increases as the fabrication of the system approaches completion.

II.5. Firmness of delivery dates is inversely proportional to the tightness of the schedule.

II.6. Dimensions will always be expressed in the least usable terms. Velocity, for example, will be expressed in furlongs per fortnight.²

II.7. An important instruction manual or operating manual will have been discarded by the receiving department.

II.8. Suggestions made by the value analysis group will increase costs and reduce capabilities.

II.9. Original drawings will be mangled by the copying machine.³

III. Mathematics

III.1. In any given miscalculation, the fault will never be placed if more than one person is involved.

III.2. Any error that can creep in, will. It will be in the direction that will do the most damage to the calculation.

III.3. All constants are variables.

III.4. In any given computation, the figure that is most obviously correct will be the source of error.

III.5. A decimal will always be misplaced.

III.6. In a complex calculation, one factor from the numerator will always move into the denominator.

IV. Prototyping and Production

IV.1. Any wire cut to length will be too short.

IV.2. Tolerances will accumulate unidirectionally toward maximum difficulty of assembly.

IV.3. Identical units tested under identical conditions will not be identical in the field.

IV.4. The availability of a component is inversely proportional to the need for that component.

IV.5. If a project requires n components, there will be $n-1$ units in stock.⁴

IV.6. If a particular resistance is needed, that value will not be available. Further, it cannot be developed with any available series or parallel combination.⁵

IV.7. A dropped tool will land where it can do the most damage. (Also known as the law of selective gravitation.)

IV.8. A device selected at random from a group having 99% reliability, will be a member of the 1% group.

IV.9. When one connects a 3-phase line, the phase sequence will be wrong.⁶

IV.10. A motor will rotate in the wrong direction.⁷

IV.11. The probability of a dimension being omitted from a plan or drawing is directly proportional to its importance.

IV.12. Interchangeable parts won't.

IV.13. Probability of failure of a component, assembly, subsystem or system is inversely proportional to ease of repair or replacement.

IV.14. If a prototype functions perfectly, subsequent production units will malfunction.

IV.15. Components that must not and cannot be assembled improperly will be.

IV.16. A d.c. meter will be used on an overly sensitive range and will be wired in backwards.⁸

IV.17. The most delicate component will drop.⁹

IV.18. Graphic recorders will deposit more ink on humans than on paper.¹⁰

IV.19. If a circuit cannot fail, it will.¹¹

IV.20. A fail-safe circuit will destroy others.¹²

IV.21. An instantaneous power-supply crowbar circuit will operate too late.¹³

IV.22. A transistor protected by a fast-acting fuse will protect the fuse by blowing first.¹⁴

IV.23. A self-starting oscillator won't.

IV.24. A crystal oscillator will oscillate at the wrong frequency—if it oscillates.

IV.25. A pnp transistor will be an npn.¹⁵

IV.26. A zero-temperature-coefficient capacitor used in a critical circuit will have a TC of $-750/^{\circ}\text{C}$.

IV.27. A failure will not appear till a unit has passed final inspection.¹⁶

IV.28. A purchased component or instrument will meet its specs long enough, and only long enough, to pass incoming inspection.¹⁷

IV.29. If an obviously defective component is replaced in an instrument with an intermittent fault, the fault will reappear after the instrument is returned to service.¹⁸

IV.30. After the last of 16 mounting screws has been removed from an access cover, it will be discovered that the wrong access cover has been removed.¹⁹

IV.31. After an access cover has been secured by 16 hold-down screws, it will be discovered that the gasket has been omitted.²⁰

IV.32. After an instrument has been fully assembled, extra components will be found on the bench.

IV.33. Hermetic seals will leak.

V. Specifying

V.1. Specified environmental conditions will always be exceeded.

V.2. Any safety factor set as a result of practical experience will be exceeded.

V.3. Manufacturers' spec sheets will be incorrect by a factor of 0.5 or 2.0, depending on which multiplier gives the most optimistic value. For salesmen's claims these factors will be 0.1 or 10.0.

V.4. In an instrument or device characterized by a number of plus-or-minus errors, the total error will be the sum of all errors adding in the same direction.

V.5. In any given price estimate, cost of equipment will exceed estimate by a factor of 3.²¹

V.6. In specifications, Murphy's Law supersedes Ohm's.

References*

- (1) H. Cohen, Roundhill Associates, private communication.
- (2) P. Birman, Kepco, private communication.
- (3) T. Emma, Western Union, private communication.
- (4) K. Sueker, Westinghouse Semiconductor, private communication.
- (5) ———, *loc cit.*
- (6) ———, *loc cit.*
- (7) ———, *loc cit.*
- (8) P. Muchnick, Sorenson, private communication.
- (9) A. Rosenfeld, Micro-Power, private communication.
- (10) J. Muchnick, *loc cit.*
- (11) R. Cushman, McCann/ITSM, private communication.
- (12) ———, *loc cit.*
- (13) ———, *loc cit.*
- (14) S. Froud, Industrial Communications Associates, private communication.
- (15) L. LeVieux, Texas Instruments, private communication.
- (16) G. Toner, Sylvania, private communication.
- (17) H. Roth, Power Designs, private communication.
- (18) W. Buck, Marconi Instruments, private communication.
- (19) A. de la Lastra, SBD Systems, private communication.
- (20) ———, *loc cit.*
- (21) P. Dietz, Data Technology, private communication.

*In some cases where no reference is given, the source material was misplaced during preparation of this paper (another example of Murphy's Law). In accordance with the law, these misplaced documents will turn up on the date of publication of this paper.

Remix Automation comes of age with a NEW PROGRAMMER by AUTOMATED PROCESSES... World leader in console automation.

Created in answer to industry need and available now, this extremely reliable programmer, the Model 1024, has been designed to accommodate every known console requirement. With over 1000 control channels, it provides functional capability for future growth as well . . . and at a reasonable price!

Unlike previous programmers, the Model 1024 uses a digital data cartridge to store programming information. During playback, data is recalled from the cartridge in sync with the program tape or other timing source . . . without accumulation of delay at each pass since timing data is included in the data on the cartridge. New data is recorded at each updating pass and previous data is formatted as part of the new data. But because previous data is retained in the cartridge, it is always possible to return to the former mix . . . and up to ten final mixes may be stored for later recall.

The system is normally referenced to an internally generated MagLink timing code recorded on one track of the multi-track tape, but the timing reference may be the output of any time code generator, or from a tape timer (thereby requiring no tracks of the multi-track tape). Since no data is recorded on the multi-track tape during remix, crosstalk problems are eliminated. The timing code track can also serve to control the audio tape machine and to synchronize

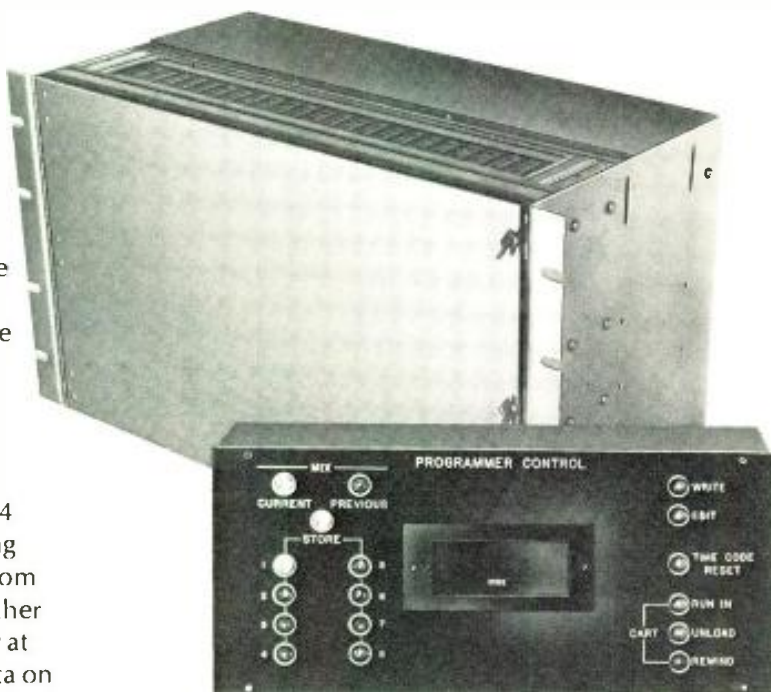

additional tape machines by means of a MagLink or Minimag Synchronizer.

Program tapes made with the Model 1024 are totally compatible from studio to studio whether the automation system used is simple or complex. What's more, this new programmer is compatible with existing consoles and can easily be retro-fitted into current installations.

If you would like to find out why audio professionals continue to prefer Automated Processes consoles and components, write or call today.

Visit us at Booths 104/105 at the AES Convention, Los Angeles Hilton, May 4-7



AUTOMATED PROCESSES, INC.
789 PARK AVENUE, HUNTINGTON, NEW YORK 11743 • 516-427-6024

Circle 43 on Reader Service Card

www.americanradiohistory.com

Closing date is the fifteenth of the second month preceding the date of issue.

Send copies to: Classified Ad Dept.

db THE SOUND ENGINEERING MAGAZINE

1120 Old Country Road, Plainview, New York 11803

Rates are 50¢ a word for commercial advertisements.

Employment offered or wanted ads are accepted at 25¢ per word.

Frequency discounts: 3 times, 10%; 6 times, 20%; 12 times, 33%.

FOR SALE

SMALL 4-16 TRACK STUDIOS. Detailed technical assistance + acoustical consultation, from our engineering division to our clients—either here or via phone, & included FREE. Music & Sound Ltd., 11½ Old York Rd., Willow Grove, Pa. 19090. (215) 659-9251.

THE ONLY ONE

CASSETTE LABELS, 1,000 on typewriter roll, \$10.98 ppd. Other formats and custom labels. TARZAC, 638 Muskogee Ave., Norfolk, Va. 23509.

PERFORM REAL TIME AUDIO ANALYSIS with your oscilloscope! Just add the new ARA-412 Acoustic Response Analyzer—\$1,450. Write for free data sheet: Communications Company, Inc., 3490 Neell St., San Diego, Ca. 92110.

CUSTOMIZED TUNED ROCK P.A.'s

Expandable high intensity touring/permanent sound systems; including narrow band [5 Hz!] feedback and ring mode suppression, detailed regenerative response environmental equalization [± 1 dB at your ears], room design / measurement / treatment, $\angle 15\%$ articulation loss of consonants; 1,000s of customized professional products, including: fiberglass horns, consoles, comp/rms/peak limiters, 18 dB continuously variable electronic crossovers, digital/acoustic/analog delays, omnipressors, flangers, reverb, echo, doubling/tripling, p.a. noise reduction, piezo transducers, frequency shifters, notch filters from . . . J.B.L./Altec pro, Tascam, U.R.E.I., Eventide, Gately, Beyer, Crown, Community, Mom's Audio, McIntosh, Allen & Heath, Cetec, Multi-Track, Orban, White, etc. All shipped prepaid + insured. Music & Sound, Ltd., 11½ Old York Rd., Willow Grove, Pa. 19090. (215) 659-9251. Inventors/Engineers

NAB ALUMINUM FLANGES. We manufacture 8", 10½", & 14". For pricing, write or call Records Reserve Corp., 56 Harvester Ave., Batavia, N.Y. 14020. (716) 343-2600.

THE LIBRARY . . . Sound effects recorded in STEREO using Dolby throughout. Over 350 effects on ten discs, \$100.00. Write, The Library, P.O. Box 18145, Denver, Colorado 80218.

\$2 MILLION USED RECORDING EQUIPMENT. Send \$1.00 for list, refundable, to The Equipment Locator, P.O. Box 99569, San Francisco, Ca. 94109. 94109.

AMPEX SCULLY TASCAM, all major professional audio lines. Top dollar trade-ins. 15 minutes George Washington Bridge. Professional Audio Video Corporation, 342 Main St., Paterson, N.J. 07505. (201) 523-3333.



THE WORLD'S LARGEST ELECTRONIC EVERYTHING HOUSE FOR THE PROFESSIONAL

The biggest "in-stock" inventory of professional audio/video equipment, parts and accessories—anywhere. The Everything House has everything for the professional . . . broadcast, audio, video, sound reinforcement and hi-fi stereo components. Quality products from over 200 leading manufacturers featuring such names as Ampex, Scully, Tascam, Sony, J.B. Lansing, Neumann, Altec, McIntosh, AKG, Crown, UREI, 3M and other major brands . . . what you want, when you want it! Consult Martin's specialists about installation . . . service . . . systems design . . . and sales for all your audio/video needs. Write for free catalog!

320 West 46th Street, N.Y.C. 10036

(212) 541-5900

**ONE STOP
FOR ALL YOUR PROFESSIONAL
AUDIO REQUIREMENTS
BOTTOM LINE ORIENTED
F. T. C. BREWER CO.
P.O. Box 8057, Pensacola, Fla. 32505**

DUPLICATORS, blank cassettes, recorders, boxes, labels, cassette albums and supplies; lowest prices, top quality. Write for free brochure, "50 Tips for Better Duplication." Stanford International, Box 546, San Carlos, Ca. 94070.

TASCAM 8-CHANNEL studio. Mint condition. \$8,500. (914) 241-2165. (914) 241-1230.

TEST RECORD for equalizing stereo systems. Helps you sell equalizers and installation services. Pink noise in ½ octave bands, type QR-2011-1 @ \$18. Use with precision sound meter. B&K Instruments, Inc., 5111 W. 164th St., Cleveland, Ohio 44142.

AVAILABLE SERVICES. Milam Audio Co. specializes in every phase of professional studio wiring, from complete systems to individual pre-wired parts and components. Available from stock: patch bays, custom mic panels, multi-paired cabling and harnesses, etc. Milam Audio Co., 1504 N. 8th St., Pekin, Ill. 61554. (309) 346-3161.

ORTOFON

DYNAMIC MOTIONAL FEEDBACK mono disc cutting systems. Complete with drive, feedback, and feedback-playback monitor amplifiers and cutterhead. All systems guaranteed. Spare cutterheads available for exchange/repair. Albert B. Grundy, 64 University Place, New York, N.Y. 10003. (212) 929-8364.

MICROMIXERS—16 inputs, E.Q., monitor mix, mic pad, mute, etc. P.A. and stereo versions. Write for literature. Gately Electronics, 57 W. Hillcrest, Havertown, Pa. 19083. (215) 449-6400.

3/M 16-track tape recorder, M-56, \$14,500. Perfect. Paul. (312) 225-2110.

RADFORD

Order Radford direct from England! Immediate dispatch by air of HD250 stereo amplifier, ZD22 zero distortion preamp, Low Distortion Oscillator ser. 3, Distortion Measuring Set ser. 3, speakers and crossovers. Send for free catalogues, speaker construction plans, etc.

WILMSLOW AUDIO

Dept. Export DB, Swan Works, Bank Square, Wilmslow, Cheshire, England

FREE CATALOG & AUDIO APPLICATIONS



CONSOLES
KITS & WIRED
AMPLIFIERS
MIC, EQ, ACN,
LINE, TAPE, DISC,
POWER
OSCILLATORS
AUDIO
TAPE BIAS
POWER SUPPLIES

OPAMP LABS, INC.
1033 N. SYCAMORE AVE.
LOS ANGELES CALIF 90038
(213) 924-3566

DISCO MIXERS. Write for free bulletin. **Berkshire Audio Products, P.O. Box 35, Great Neck, N.Y. 11021.**

A FEW competitively priced used Revox A77 decks available. Completely reconditioned by Revox, virtually indistinguishable from new and have the standard Revox 90-day warranty for rebuilt machines. Satisfaction guaranteed. Example, A77 with Dolby, \$675, plus shipping. Write requirements to **ESSI, Box 854, Hicksville, N.Y. 11802. (516) 921-2620.**

Neumann recording console, 18 input, \$14,000 (originally \$35,000) Scully 8-track with remote control, can be expanded to 12 tracks, \$7,000. Neumann lathe with Westrex 2-B mono system plus accessories, reasonable. Pentagon cassette duplicator, reel/cassette, cassette/cassette, \$1,000. Ampex AG-500 stereo, \$1,250. Ampex PR 10 stereo, \$600. **Paul. (312) 225-2110.**

WE WILL BETTER anyone's price on new Recordex high speed cassette duplicators. Your written request can save you a bundle. Also get our large-user cassette deal. **Tape and Production Equipment Company, 2080 Peachtree Industrial Court, Atlanta, Ga. 30341. Phone (404) 458-TAPE.**

PRO AUDIO EQUIPMENT & SERVICES

Custom touring sound, 2-, 4- and 8-track studios, disco systems. Representing Akai, AKG, Altec, Beyer, BGW, Cetec, Cerwin-Vega, Community Light & Sound, dbx, Dynaco, Dokorder, E-V, Gauss, Lamb, Langevin, 3M, Martex PM, Maxell, Meteor, Russound, Revox, Sennheiser, Shure, Sony, Soundcraftsman, Sound Workshop, Spectra Sonics, Switchcraft, TDK, TAPCO, TEAC, Technics, Thorens, and more. Offering these professional services: custom cabinet design, room equalization, loudspeaker testing, custom crossover design, electronics modification, and custom road cases. Call or write for quotes, or drop us a line for our latest catalogue. **K & L Sound, 75 N. Beacon St., Watertown, Mass. 02172. (617) 787-4073. (Att: Ken Berger)**

CLASS D SWITCHING AMPS; B.B.C. reference monitors; pre-equalized J.B.L./Altec transducers; Nakamichi mastering cassettes; I.M.F. transmission lines; Ampex/Scully/Crown/Revox A-700 recorders/tapes; Mic-mix / Orban / Multi-Track reverbs; Eventide flangers / omnipressors; Parasound stereo synthesizers / parametrics; Lexicon digital delays; dbx/Burwen N.R. companders; Little Dipper hum/buzz notch filters; Cooper Time Cube echo send/doubler; moving coil Denon/Ortofon; B&O/Rabco straight line arms; Beyer condensers/ribbons; U.R.E.I. comp/limiters; White equalizers/filters; 1,000s more. **Music & Sound Ltd., 11 1/2 Old York Rd., Willow Grove, Pa. 19090. (215) 659-9251. Enclosure Designs Included—FREE**

ELGENCO model 602A-1390 solid state Gaussian noise generator, used, good condition. \$150. Full specs on request. **R. Smith, P.O. Box 528, Moss Beach, Ca. 94038. (415) 728-5086.**

COMMUNITY LIGHT & SOUND professional sound reinforcement products. **Brandy Brook Audio, P.O. Box 165, Seymour, Conn., 06483. (203) 888-7702.**

MODERN RECORDING TECHNIQUES by Robert E. Runstein. The only book covering all aspects of multi-track pop music recording from microphones through disc cutting. For engineers, producers, and musicians. \$9.95 prepaid. **Robert E. Runstein, 44 Dinsmore Ave. Apt. 610, Framingham, Mass. 01701.**

ARP SYNTHESIZERS! Strings, \$1,385; 2600, \$2,260; Axex, \$730; Prosoloist, \$875; Odyssey, \$1,165. **Dickstein Distributing, 1120 Quincy, Scranton, Pa. 18510.**

CASSETTE WINDERS: Ramko Research ACL-25's: excellent condition; \$256 both. **TARZAC, 638 Muskogee Ave., Norfolk, Va. 23509.**

FOR SALE: LARGE MOOG with two keyboard controllers, one ribbon controller and custom cabinet, \$4,950. **Woodland Sound Studios, Nashville, Tenn. (615) 227-5027.**

When precision quality is important!



AEG-TELEFUNKEN TUBES

HARRISON ELECTRONICS
20 Smith St. Farmingdale, N.Y. 11735
(Dealers invited)

DISCOUNTS!
on
Disco & Audio Equipment.
Low Prices on New Equipment
Amps, Turntables, Mixers & Tape-
Decks by Thorens, Dynaco, ESS,
Crown, Technics, GLI, Meteor,
EEC, Teac & many more.
Call or Write:
US Stereo
Route 35, Eatontown N.J. 07724
201-542-7000

DO YOU WANT TO DESIGN YOUR OWN DISCOTHEQUE CONTROL CENTER? Request information about the new EMS—modules from RIM—Electronics, West Germany. (Electroacoustics Mini System) Exclusively imported by: **D.T.S., Dept. EMS, P.O. Box 16049, Seattle, Wa. 98116.**

1800 WATT ISOLATION TRANSFORMERS. \$150, F.O.B. **Pragmatech Sound, 70 Sheldrake Pl., New Rochelle, N.Y. 10804. (914) 633-8556.**

ELECTRO-VOICE SENTRY PRODUCTS. In stock: Sentry IV-A, Sentry III, and Sentry II-A monitor loudspeaker systems for professional monitoring and sound reinforcement. Immediate air freight shipment to any N. American destination. **National Sound Corp., Ft. Lauderdale, Florida. (305) 462-6862.**

FOR SALE: (All items in excellent condition.) One Neumann QM-69 F.T.E. quadruphonic microphone w/pwr supply, \$1,350 ea. One Ampex AM-10 mixer w/ meter panel and carrying case, \$400 ea. Contact: **Thomas W. Bethel, Director, Audio Services, Oberlin College, Oberlin, Ohio 44074. (216) 775-8272.**

THE AUDIO AMATEUR: The quality constructor's quarterly teaches, publishes tested construction projects, transmission lines, electrostratics with 900W direct drive tube amplifier, electronic crossovers, mixers, preamps, 9-octave equalizers. Detailed equipment modifications, maintenance, kit reports. \$9 year. Free prospectus tells all. **Audio Amateur, Box 176d, Peterborough, N.H. 03458.**

NAGY SHEAR-TYPE TAPE SPLICERS



FOR CASSETTE 1/4 & 1/2 IN. TAPES

- HAND-CRAFTED
- FIELD PROVEN
- FAST, ACCURATE
- SELF-SHARPENING

NRPD Box 289 McLean, Va. 22101

(continued)

FOR SALE

CUSTOM CROSSOVER NETWORKS to your specifications; a few or production quantities. Power capacities to thousands of watts; inductors and capacitors available separately; specify your needs for rapid quotation. Also, PIEZO ELECTRIC TWEETERS—send for data sheet and price schedules. **TSR ENGINEERING, 5146 W. Imperial, Los Angeles, Ca. 90045. (213) 776-6057.**

STUDIO SOUND—Europe's leading professional magazine. Back issues available from June '73 through June '75. \$1 each, postpaid. **3P Recording, P.O. Box 99569, San Francisco, Ca. 94109.**

WHATEVER YOUR EQUIPMENT NEEDS—new or used—check us first. We specialize in broadcast equipment. Send \$1.00 for our complete listings. **Broadcast Equipment & Supply Co., Box 3141, Bristol, Tenn. 37620.**

CREATIVE CASSETTE & CARTRIDGE LABELS. Custom designed; small and large runs; cassette, cartridge duplication. **Omega Audio, 25520 Graham, Detroit, Mich. 48239.**

FOR SALE: USED AND DEMO Altec pro sound equipment; Ampex and Scully tape recorders; 8-, 4-, 2-track and mono. **Dimension Five Studios, Inc. Womelsdorf, Pa. 19567. (215) 589-5312.**

A-62 STEREO STUDER, magnificent condition, \$1,775; 1-inch Sony video recorder with video color pack, like-new condition, professional model E-V 320, \$995; Revox 630-III 2-track stereo, 7½ and 15 i.p.s., takes 10½ in. reels, great condition, \$350. **Call (212) 799-4830.**

PATCH CORDS, new 3 ft. Switchcraft tip-ring-sleeve (PJ-051R plugs). Commercial overstock makes these available at \$5.25, which is below dealer cost. No minimum, dealers welcome, satisfaction guaranteed. Shipped prepaid or C.O.D. NOTE: NEW BOX NUMBER. (Post Office error sent letters back, please write again.) **Kapes Audio Supply, P.O. Box 5045, River Station, Rochester, N.Y. 14627.**

DYNACO RACK MOUNTS for all Dynaco preamps, tuners, integrated amps. \$24.95 postpaid in U.S., \$22.50 in lots of three. **Audio by Zimet, 1038 Northern Blvd., Roslyn, N.Y. 11576. (516) 621-0138.**

INFONICS DUPLICATORS! For a bunch of reasons, you can't afford not to consider Infonics Duplicators—especially since factory installation and training are included in the list price. **INFONICS DUPLICATORS, (219) 879-3381.**

AMPEX SPARE PARTS; technical support; updating kits, for *discontinued* professional audio models; available from **VIF International, Box 1555, Mountain View, Ca. 94042. (408) 739-9740.**

DON'T MISS THE "DISCO WAGON"! Excellent complete line of discotheque equipment from West Germany is available to fulfill your needs. Request your information package today. Write to: **D.T.S., Dept. DISCO, P.O. Box 16049, Seattle, Wa. 98116.** Reserve your territory in time!

MCI input modules, \$550.00 each. Tested and Guaranteed. **Paul. (312) 225-2110.**

MCI . . . DOLBY. Two great names! Two great products! For authorized factory representation in the progressive Midwest, contact: **Jerry Milam, Milam Audio Co., 1504 N. 8th St., Pekin, Ill. 61554. (309) 346-3161.**

CERWIN-VEGA pro, full range speaker systems; bass horn, including the 2k rms Earthquake double-D horn; mid-range horns; high frequency horns; musical instrument speakers; stage monitors; disco systems; power amps; equalizer and mixers with lifetime speaker warranty. A New England exclusive at **K & L Sound Service, 75 N. Beacon St., Watertown, Mass. 02172. (617) 787-4073. (Att: Ken Berger)**

SCULLY 280B 2-track in console with remote; less than 1 year old; excellent condition; \$3,700. Going to machine with auto locator. **Audio-Trak Recording. (815) 968-2902.**

DISTRESS SALE: Scully/Westrex stereo mastering system. Scully lathe w/variable pitch; 3D-IIA cutter head—and more. Top working condition (New York) \$11,500. Contact: **R. Blinn, 3061 Fletcher Dr. Los Angeles, Ca. 90065. (213) 254-9111.**

NEUMANN STEREO CUTTING SYSTEM: 2 LV-60 amps and 2 GV-2A feedback amps; one WV-2A feedback/monitor amp; one SI-A circuit breaker; one Ortofon 631 h.f. limiter. \$3,000. **Paul (312) 225-2110.**

TOURING SOUND SYSTEMS; 2-, 4-, and 8-track studios. Disco Sound, Cerwin Vega, BGW, Altec, Shure, AKG, Tapco, Dyna, Revox, E-V, Beyer, Cetec, etc. **K&L Sound Service, 75 N. Beacon St., Watertown, Mass. 02172. (617) 787-4072. Attention: Ken Berger.**

PROKITS—SM-6A and SPM-6. Your best mixer value. Write for literature. **Gately Electronics, 57 W. Hillcrest, Havertown, Pa. 19083. (215) 449-6400.**

ELECTRO-VOICE Pro, E. V. Sentry & TL series, Shure, Atlas, Sound Workshop, Emilar and more—custom built systems, snakes, etc. For more information, please write or call **PSP, 5905 Wolf Creek Pike, Dayton, Ohio 45426. (513) 837-1025.**

ROCK P.A. Complete p.a. packaged for touring. All professional components. Will sell as complete package or piecemeal. Includes 20-channel Mom's board; U.R.E.I. EQ's and limiters; Phase Linear amps, J.B.L. woofers and drivers; Community speaker enclosures; cables, microphones. Call or write for details. **Activated Air Audio Services, Inc. 1012 Waverly St., Philadelphia, Pa. 19147. (215) 627-3339.**

TASCAM WARRANTY SERVICE STATION. Mixing consoles, \$1,350; ½" recorders, \$1,950; 8-track machines, \$2,950. All shipped prepaid & insured, including free alignment + equalization + bias + calibration + life test. **Music & Sound Ltd., 11½ Old York Rd., Willow Grove, Pa. 19090. (215) 659-9251. Note Special Prices**

REELS AND BOXES 5" and 7" large and small hubs; heavy duty white boxes. **W-M Sales, 1118 Dula Circle, Duncanville, Texas 75116. (214) 296-2773.**

DECOURSEY ELECTRONIC CROSSOVERS

Complete with plug-in Butterworth filters of your specified frequencies and with 6, 12, or 18 dB/octave attenuation; regulated power supply; bi-amp or triamp for monaural, stereo, or quadriphonic systems. Other options: electronic summer for single woofer stereo; VLF noise filters. For OEM and home builders: Series 500 and 600 Hi-pass and Low-pass filter pairs. Also regulated power supplies. Write for brochure. **DeCoursey Engineering Laboratory, 11828 Jefferson Blvd., Culver City, Ca. 90230.**

WANTED

WILL TRADE SYNTHESIZERS for professional audio and video equipment. New Electron Farm—CBS Buchla synthesizers for: multi-track decks and electronics, amplifiers, monitors, microphones, mixing consoles, etc., video decks, cameras, monitors, etc. **Gregory Kramer, Electron Farm, 135 W. Broadway, New York, N.Y. 10013. (212) 349-0098. Los Angeles (213) 396-6339.**

WE ARE INTERESTED in buying a complete studio or individual pieces of equipment. Contact **Bradley Recording Company, 531 N. Howard St., Baltimore, Md. 21201. Phone (301) 727-0950.**

WANTED: PARTS OR SERVICE. 1973 Tapesonic 70A-TRSH recorder. Write **RD-1, Box 95, Stone Ridge, N.Y. 12484.**

WANTED: J. B. LANSING amplifiers Model SE400, 500 and 600 series; Altec 770A, 3001; Hadley 622, 621; Marantz 7C, 9; McIntosh C22, MC275. State price and condition. Call (212) 697-9226 or write **Bornstein Electronics, 507 Fifth Ave., New York, N.Y. 10017.**

WANTED: AUDIO RECORDING CONSOLE; 16 inputs/4+ out, full EQ. Contact **David Boston, WCDR-FM, Box 601, Cedarville, Ohio 45314. (513) 766-5595.**

WANTED, J.B.L. pro dealers to handle high end multi-channel consoles on exclusive basis. Designed to augment J.B.L. pro line of speakers and amplifiers. **Theatre Sound, Inc. P.O. Box A.Q., New Haven, Conn. 06525.**

EMPLOYMENT

C. E. MAJOR, New York disc-mastering studio, looking for greener pastures. Extensive experience engineering/management most areas audio recording. Would consider relocating. (212) 799-7023 after six.

AUDIO ENGINEER—S. California Systems engineer with electronic contracting experience. Education and experience in audio, acoustics, project management/implementation, and circuit design. Submit resume and salary history to: **Contractor, Box 721, Van Nuys, Ca. 91408.**

RECORDING ENGINEER needed for eight and sixteen-track recording studio. Must have worked previously in the recording industry, have a good knowledge of music and musical arrangement. Must have a little technical knowledge for minor repairs, be able to record all kinds of music, and be able to communicate to the people in their area of music. Neat appearance. Send resume to **Cinema Sound, Inc., 1635 South Division, Grand Rapids, Michigan 49507.**

OPPORTUNITY FOR AGGRESSIVE recording engineer and mixer. Must have a common sense business attitude and be a professional in every aspect of the business. We record and produce for America's largest labels. Outstanding facility: 16-track, dbx, etc. Applicant must be able to repair and perform maintenance. Send resume immediately. **Box 31, db Magazine, 1120 Old Country Rd., Plainview, N.Y. 11803.**

EXPERIENCED MUSIC MIXER

For major N.Y.C. studio, expanding staff. Send resume to **Box 11, db Magazine, 1120 Old Country Rd., Plainview, N.Y. 11803.**

ONE EQUALS TWO

With the Sound Workshop Model 220 VOCAL DOUBLER, one piano, one voice, one drum set, become two. Or five sounds become ten. Or mono signals expand into stereo. The Sound Workshop 220 is the tool; your creativity is the means.

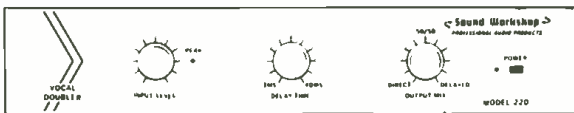

The Sound Workshop Model 220 VOCAL DOUBLER is an analog electronic delay line, which uses the latest charge coupled integrated circuits. The delay time is continuously variable from 5 milliseconds to 40 milliseconds. Internal mixing is provided to allow its use with any system, from a simple tape deck or PA system, to the most complete studio set-up. At \$500, it just might be the best bargain on the pro-audio scene.

And speaking of bargains, the Sound Workshop 242 Stereo Reverberation System has become the new standard for inexpensive reverb units. A lot of great sound for just \$375.

All Sound Workshop products reflect our philosophy of designing and manufacturing studio quality products at less than studio prices.

For example, our line of recording/PA mixing consoles provides unprecedented performance. Our

top rated 882M, at \$1500, is a full studio or PA console, with 8 inputs and 2 outputs (plus direct outputs on every channel for multitrack recording), EQ, panning, echo and monitor sends, first stage trim control, line/mic switching, output meters, complete monitoring facilities, and our unique transformerless mic input circuit that provides exceptional transient response and ultra-low distortion. For \$1200, the 882 provides the same features and performance, but without the meter/monitor panel. Our new model 840 is a four out version, offering the same studio performance for just \$850.

We also build electronic crossovers, disco mixers, and a host of other useful studio accessories, all with the Sound Workshop philosophy of high quality, with a not so high price.

Sound Workshop Professional Audio Products carry a two year parts and labor warranty, and are available from a growing number of qualified audio dealers.

For complete information about our products, circle the number below on the reader service card, drop us a line, or give us a call.

Sound Workshop
PROFESSIONAL AUDIO PRODUCTS

bringing the technology within everyone's reach

Audio by Zimet, 1038 Northern Blvd., Roslyn, Long Island, N.Y. 11576—(516) 621-0138

Circle 44 on Reader Service Card

www.americanradiohistory.com

db people/places/happenings



McGEOY



LEON



KOSS



SCHREIBER



SNITZER



SCANDALIOS

● **Frank McGeoy** has been promoted to the post of national field sales manager of the **Spectrol Electronics Corp.** of the City of Industry, California. **Dan Mathews** will succeed Mr. McGeoy as distributor sales manager.

● **Joseph L. Leon** has been named national sales manager for **3M Company's** Magnetic Audio/Video Products Division, based in St. Paul, Minn. Mr. Leon has been with 3M since 1959.

● Covering the mountain and west coast states, as well as Hawaii, **Charles F. Rockhill** has been appointed western sales manager by **McMartin Industries, Inc.**, Omaha, Nebraska. The firm has also named **C. Harrison Associates** of Atlanta, Georgia as broadcast sales representatives for the southeast.

● **Norman Hansen** has been promoted to the post of sales manager of the **Telex Communications RF** products group, of Minneapolis, Minn. **William Kothman** was named product manager for the group, which develops and markets communications headphones and microphones for two-way radios.

● **General Radio Company**, of Concord, Mass., has changed its name to **GenRad, Inc.** The reason for the change is that the old name, formulated in 1915, no longer conveys the function of the company, which does not manufacture radios, but produces computer-controlled automatic test systems.

● A newly conceived position, manager of sales development and proposals for **RCA Broadcast Systems**, Camden, N.J. has been filled by **Jack E. Banister**. Before joining RCA in 1973, Mr. Banister was with **Racal Communications** and **Raytheon**.

● **John C. Koss**, founder and chief executive officer of the **Koss Corporation**, Milwaukee, Wis., was selected as Sales and Marketing Executive of the Year 1975-76 by the **Sales and Marketing Executives** of Milwaukee. The award recognizes outstanding professionalism in sales and marketing, particularly in the use of innovative sales and marketing techniques.

● Administration of the new Akai Action Line of the **Akai America, Ltd.** of Los Angeles will be in the hands of **Anita Schreiber**. Ms. Schreiber will act as liaison between the firm's headquarters and audio dealers, and will supervise the activities of three account executives, as well as serving provisionally as eastern regional account executive.

● **Uher of America** has appointed new sales representatives. **Cir-Vu Marketing**, of Denver, Colo., **KSW Associates**, Kansas City and St. Louis, Missouri, and **Cowan Associates**, of Milton, Mass.

● **Carroll C. Abernathy** of Elk Grove Village, Illinois has been appointed manufacturer's representative for **Electro Sound, Inc.** Mr. Abernathy, who was formerly with the **Ampex Corporation**, will serve Ohio, Indiana, Illinois, Michigan, and Wisconsin.

● **Eric Fleetwood** has joined the sales and marketing staff of **U.S. Pioneer Electronics Corp.**, Moonachie, N.J. Mr. Fleetwood, who will be based in Gardena, Ca., will serve the western region. He was formerly with **Audio Magnetics**.

● The annual summer Audio Recording Technology Workshop at **Brigham Young University** will be held June 21—July 9. The Workshop, which carries three hours of college

credit, will focus on the application of basic electronics, physics, and acoustical principles in the field of recording and sound reinforcement operation. Prospective students are urged to register early. The address is: Special Courses and Conferences, Brigham Young University, Audio Recording Technology Course, 242 HRCB, Provo, Utah 84602.

● **Milton Snitzer**, former editor of **Popular Electronics**, has been named to the post of director of public relations of **Jarman, Spitzer & Felix, Inc.**, of New York City. The firm is an advertising and public relations agency with accounts in the industrial, scientific, and consumer market areas.

● **John N. Scandalios** has been elected president of **Triangle PWC Inc.**, Holmdel, N.J. **James B. Baxter**, who has resigned as president of the company, will continue to serve as a consultant.

● **North American Philips Corporation** has formed a new high fidelity company designated as **Philips High Fidelity Laboratories**. **Gerald Orbach** has been appointed president and general manager of the new unit. The new company will be headquartered at Ft. Wayne, Indiana.

● **Nicolay E. Johannsen** has been appointed vice president of finance and chief financial officer of **Superscope, Inc.** of Sun Valley, Ca. Mr. Johannsen has previously been affiliated with **General Tire International** and the **Ampex Corporation**.

NUMBER ONE



SON AND GRANDSONS



SON 52 inputs
26 mixing positions



GRANDSON 36 inputs
18 mixing positions



GRANDSON II 48 inputs
24 mixing positions

For years, the Audiotronics family of consoles has produced sound leaders. From New York to Bangkok.

Our Son and Grandsons deliver faultless performances night after night. In front of the most hardened authorities.

Yet our success is no mystery. In both recording and the broadcast industry, Audiotronics has become a standard for craftsmanship and technology. A reputation won on the firing line.

Think about it. And don't make a sound without calling us first. Leasing/Financing Plans Available.

 **audiotronics, inc.**
P.O. Box 12637 • Memphis, Tenn. 38104 • 901/276-6338

You make it professional.

You provide the talent and our new half-inch 8-track will do the rest. You get full frequency response in the sync mode, and integral DBX interface is available optionally – 8 tracks and then some.

The 80-8

Full IC logic circuitry including motion sensing gives you positive, smooth control over all transport functions. And with automatic sync switching, overdubbing and punching-in are easy.

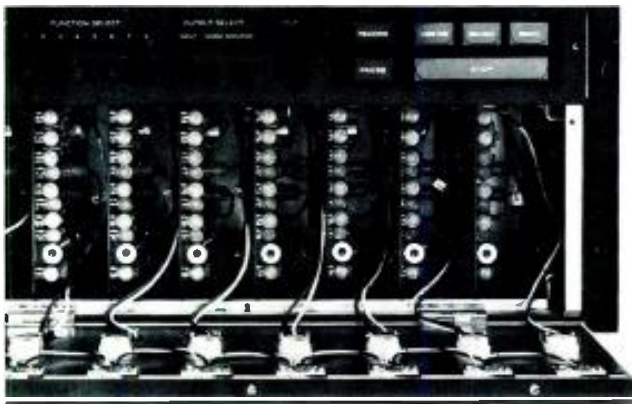

So is routine maintenance. Remove two front panel screws and the meter section swings down to give you immediate access to the EQ, bias, and level controls.

Everything you need to produce a commercial product. At a price very much in keeping with the whole tascam idea:

Less than \$3000.00*

So if you've been wanting to go 8-track, wishing there was a way...there is. Check out the 80-8 at your TEAC Tascam Series Dealer – just call (800) 447-4700 or in Illinois, (800) 322-4400, to find the one nearest you.

*Nationally advertised value. Actual resale prices will be determined individually and at the sole discretion of authorized TEAC Tascam Series dealers.

TEAC® TASCAM SERIES

TEAC Corporation of America 7733 Telegraph Road, Montebello, Ca. 90640 ©TEAC